



EPSON

*EPSON TEST NDM
for PX-8*

TECHNICAL MANUAL
PX-8

INTRODUCTION

The EPSON PX-8 is a general-purpose portable computer driven by an incorporated rechargeable battery. Standard features include a micro cassette drive, ROM capsule and RS-232C interface allowing the machine to independently handle a variety of applications. The system can also be expanded by connecting peripheral equipment such as a printer. Long time steady operation has been realized by employing the battery-powered supply system with its large capacity of 1100 mAH. A recharge control circuit to protect the battery from overcharge and an auxiliary battery (90 mAH) for backup have been added to enhance reliability.

TABLE OF CONTENTS

CHAPTER 1	GENERAL DESCRIPTION
CHAPTER 2	PRINCIPLES OF OPERATIONS
CHAPTER 3	OPTION (PRINCIPLES OF OPERATIONS)
CHAPTER 4	DISASSEMBLY/ASSEMBLY
CHAPTER 5	TROUBLE SHOOTING
CHAPTER 6	MAINTENANCE
CHAPTER 7	APPENDIX

CHAPTER 1

GENERAL DESCRIPTION

1.1 Specifications	1-1
1.2 Name of Major Parts	1-4
1.3 Major Parts	1-5
1.4 Interface	1-8
1.5 Connection Cable (option)	1-15

1.1 Specifications

- (1) Dimension: 297 mm (width) x 216 mm (depth) x 47 mm (height)
- (2) Weight: Approx. 2.3 kg
- (3) Environment:
- Temperature

Operating	5 ~ 35°C
Recharging	5 ~ 35°C
Not operating	-20 ~ 60°C (below 30°C for a long period of time)
Storing data (not operating)	0 ~ 40°C
 - Humidity

Operating	10 ~ 80% (non-condensing)
Not operating	5 ~ 85% (non-condensing)
- (4) Power:
- Consumption: Approx. 325 mW (when micro cassette, speaker, ROM capsule, RS-232C, SERIAL are not operating)
 - Battery: Two Ni-cd rechargeable batteries

	Main battery	Auxiliary battery
Voltage	4.8V	4.8V
Capacity	1100 mAH	90 mAH
Charging current	330 mA MAX.	10 mA MAX.
Charging voltage	5.6 ~ 6.4V	5.7 ~ 6.0V

- AC adapter output: 6.0V, 600 mA
- (5) Keyboard: 72 keys (include 9 function keys)
3 mode indication lamps
- (6) LCD: 480 (width) x 64 (height) dots (80 x 8 characters per screen)
1/64 duty, adjustable VIEW ANGLE
- (7) Microcassette™:
- | | |
|--------------------------|--------------------------------|
| Tape speed | 2.4 cm/s |
| Drive | Center capstan |
| Track | Two-track, one-channel |
| Frequency characteristic | 315 ~ 4KHz |
| Data file | Sequential file with directory |
- (8) Interface
- RS-232C:

Connector	8-pin mini-DIN connector
Voltage	± 8V (ON/OFF control by software)
Transmission speed	75 ~ 19200 BPS
Mode	Full duplex/half duplex

- SERIAL: Connector 8-pin mini-DIN connector
Voltage $\pm 8V$ (ON/OFF control by software)
Transmission speed 150, 600, 4800, 38.4K BPS
- Speaker: Audio response controlled by software or by micro cassette (with adjustable volume)
- Analog input: Input voltage 0 ~ 2.0V
A/D converter 6-bit (Resolution: approx. 0.03V)
- Bar code: Can connect to high-resolution (0.19mm) or low-resolution (0.33mm).

(9) CPU and memory

- Main CPU: Z-80, 2.45MHz
- Slave CPU: 6303, 614kHz
- Auxiliary CPU: 7508, 200kHz (with battery backup)
- Main RAM: 64kB D-RAM (with battery backup)
- Video RAM: 6kB static RAM (with battery backup)
- ROM: 32kB
- ROM capsule: Two capsules can be incorporated.
(8 ~ 32kB per capsule)

1.1.1 Available models

The following models are available for this computer. However, major differences among these models are restricted to keyboard and AC adaptor specifications, the internal hardware is the same.

Table 1-1

Model	Keyboard	AC adaptor
H101A AA	ASCII (U.S.A.)	H00AAA: 120V 60 Hz
H101A AC	ASCII	H00AAA: 120V 60 Hz, H00AAU-B: 240V 50 Hz, H00AAU-A: 240V 50 Hz
H101A BA	HASCII (U.S.A.)	H00AAA: 120V 60 Hz
H101A UA	England	H00AAU-A: 240V 50 Hz
H101A FA	France	H00AAF: 220V 50 Hz
H101A GA	Germany	H00AAG: 220V 50 Hz
H101A SA	Sweden	H00AAG: 220V 50 Hz
H101A DA	Denmark	H00AAG: 220V 50 Hz
H101A NA	Norway	H00AAG: 220V 50 Hz

1.1.2 Specifications of option

Optional features are summarized in the table below. They provide you with system expansion to meet your specific demands or flexible system configuration by using universal option.

Table 1-2

Name	Application/Description
#723 cable	For floppy disk drive (serial)
#724 cable	For acoustic coupler (RS-232C)
#725 cable	For printer (RS-232C)
#726 cable	Null modem (for interconnection between two EPSON PX-8 computers via RS-232C interfacing)
CX-20/21	Acoustic coupler
PF-10	3.5 inch floppy disk drive
TF-15/TF-20	5.25 inch floppy disk drive
RAM DISK UNIT	Additional 120/60 kB RAM
UNIVERSAL UNIT	A through-hole circuit board and a case
MODEM UNIT	Built-in modem (for U.S.A. only)
MULTI UNIT	RAM + MODEM (for U.S.A. only)
EPSON PRINTER	Various models with RS-232C interface

1.2 Names of Major Parts

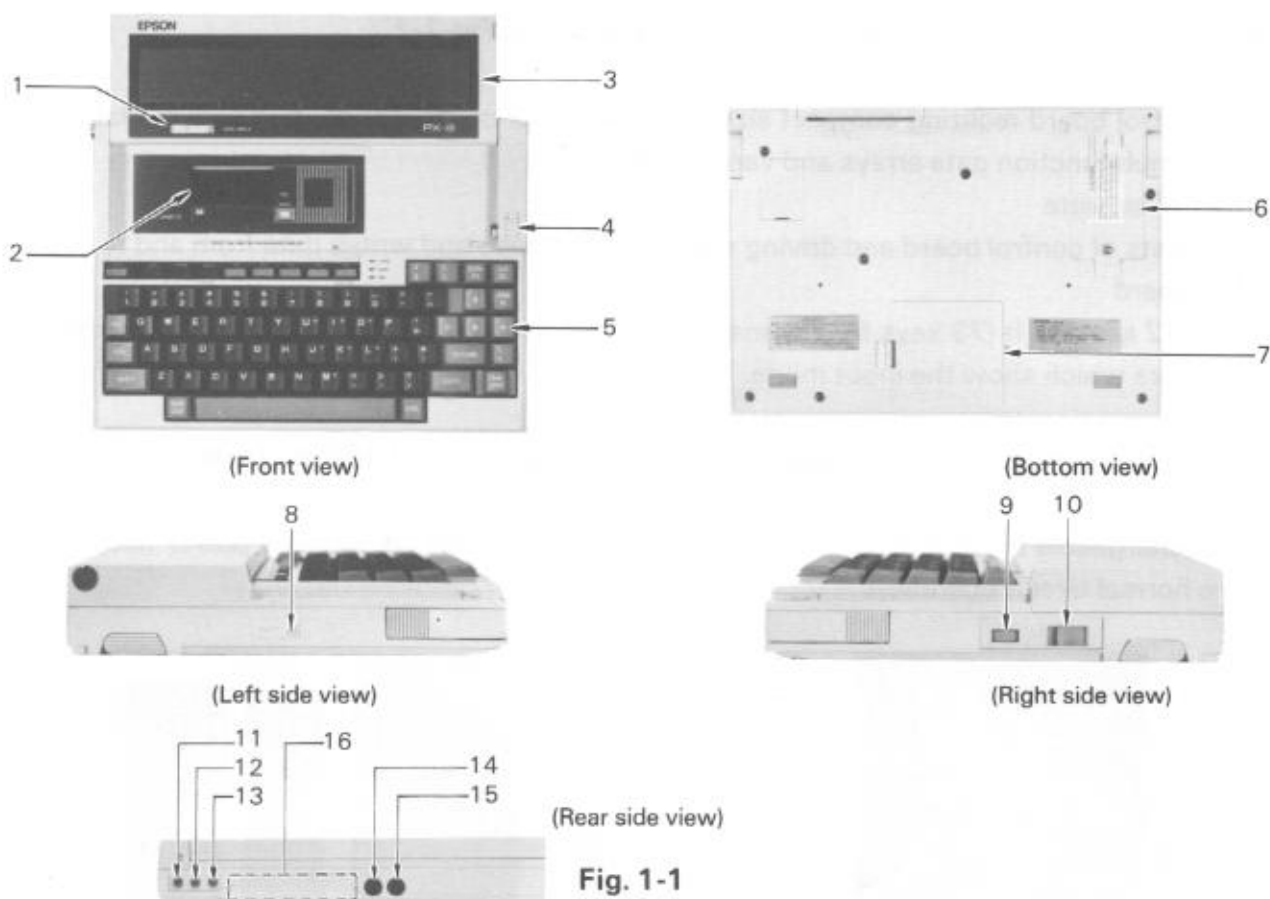

Fig. 1-1

Table 1-3 Major Component

No.	Name
1	VIEW ANGLE VOLUME (adjustable view angle due to temperature complement)
2	Microcassette (program load/save and sound generation)
3	LCD panel unit
4	LCD panel open switch
5	Keyboard unit
6	Battery cover (to replace main battery)
7	ROM cartridge cover (for replacement of ROM capsule, and INITIAL RESET)
8	Reset switch
9	Speaker volume (internal/external speaker volume adjustment)

No.	Name
10	Power switch
11	Speaker output (for external speaker)
12	Analog input interface (analog input/ joystick)
13	Bar code reader interface
14	RS-232C interface (for connection to acoustic coupler/printer, etc.)
15	High-speed serial interface (for connection to floppy disk drive)
16	Expansion interface (for connection to optional unit/universal unit)

1.3 Major parts

The main unit consists of five parts and a case as shown in Fig. 1-2.

① MAPLE board

A control board realizing compact size and low power consumption with CMOS, flat package type multifunction gate arrays and various chips on it.

② Micro cassette

Consists of control board and driving mechanism. Reads and writes data from and to the tape.

③ Keyboard

Has 72 keys on it (73 keys for Japanese use), 9 of which are function keys. Also has three indicators which show the input mode.

④ LCD

Consists of 480 (width) x 64 (height) dots, can display a total of 480 characters.

⑤ Main battery

A rechargeable Ni-cd battery with a capacity of 1100 mA·H. It supplies power necessary for the normal circuit operation.

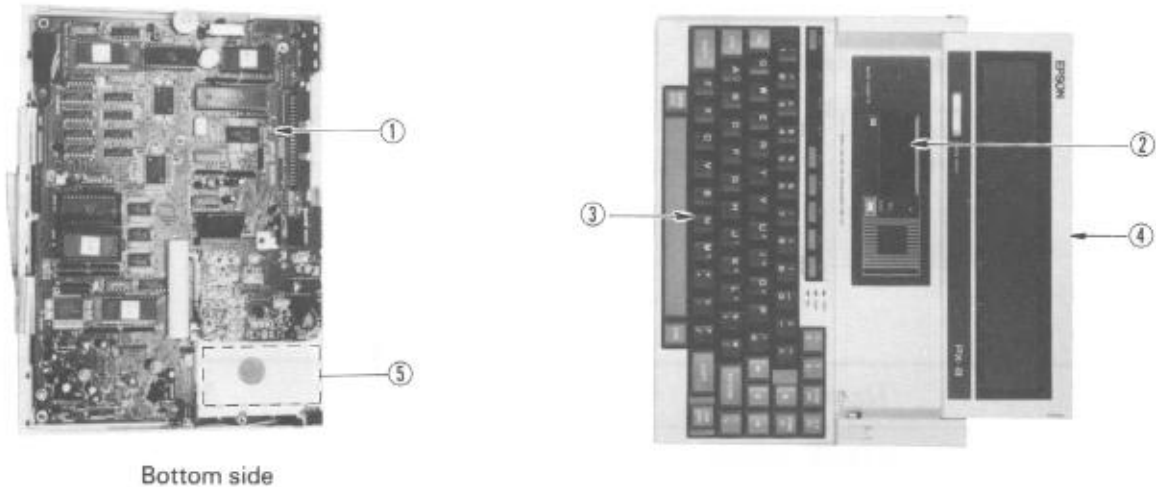
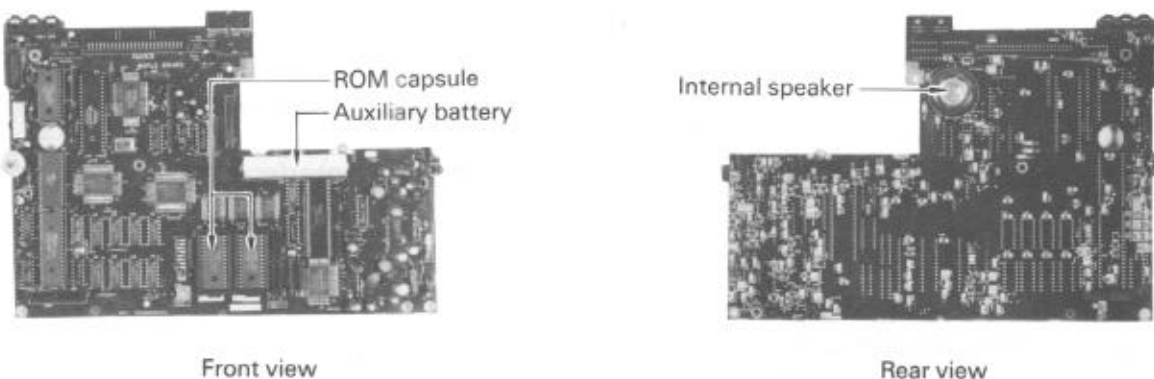

Fig. 1-2

1.3.1 MAPLE board

Power consumption is considerably reduced by employing power-saving C-MOS. On-board integration has become easy by employing customized LSIs and chips. Although both sides of the boards are utilized, the back side mainly includes chips such as resistors and capacitors.



Rear view

Fig. 1-3

External interfaces (shown in Table 1-4) and two ROM capsules on the board provide a system configuration suitable for your needs or implementation of an application program. An auxiliary rechargeable battery of 90 mA·H is also incorporated which supplies power in order to ensure normal circuit operation when the voltage of the main battery falls down below a certain value.

Table 1-4 External Interfaces

Item	Function	Note
RS-232C	110 ~ 19200 BPS, RS-232C level	Operator-selectable: transmission speed, X-ON/OFF, etc.,
SERIAL	38400 BPS MAX., RS-232C level	Operator-selectable: transmission speed, X-ON/OFF, etc.,
Bar code	Read at TTL level	Read program and bar code reader are required.
Analog input	Analog or joystick input (with trigger)	Analog input line has +5V pull up function.
External speaker	0 ~ 6V output	8Ω 0.2W

1.3.2 Microcassette

The microcassette consists of a control board and drive mechanism. Operations such as FF, REW, etc. are controlled by software, resulting in high reliability compared with manual control. Increased chip implementation has permitted a reduction in size of the control board. This cassette drive operates at a tape speed of 2.4 cm/s, and reads or writes data effectively utilizing a tape counter and directory which contains file names, file starting addresses, etc.



Fig. 1-4

Mechanical components include a tape drive motor and its driving mechanism, R/W heads and their mechanisms, reels, etc. The control board controls the revolving speed of motor, load/unload of R/W heads and R/W operation.

To enable sound output, it provides signals to an internal or external speaker after amplifying them twice. For reading data, duplicated amplification circuits eliminate high frequency component (noise) and detect the peak of signal to ensure highly reliable sound output.

1.3.3 Keyboard

Matrix keyboard uses mechanical contact switches. Switches, reverse-current protection diode and mode indication LED lamps are implemented on the control board.



Fig. 1-5

1.3.4 LCD

The LCD is a twist pneumatic (TNM) effect type liquid-crystal display. The screen angle can be changed arbitrarily. VIEW ANGLE volume is provided to correct the change of liquid crystal display condition caused by temperature rise or fall.

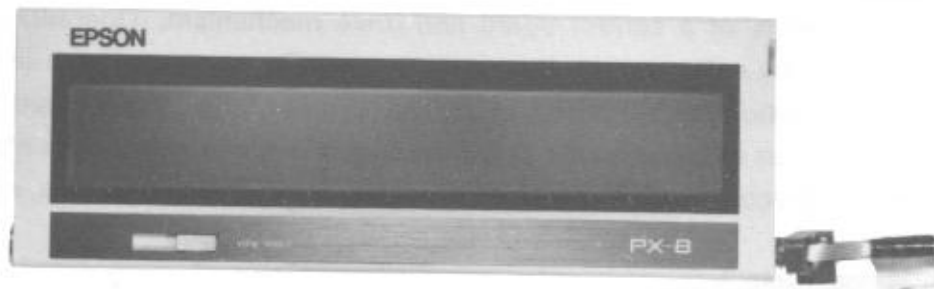

Fig. 1-6

1.3.5 Main battery

The main battery is Ni-Cd with a nominal voltage of 4.8V. When the battery is fully charged, the voltage is 5.0V or more, enough to provide power for circuit operation. The battery can be easily removed and replaced by removing the battery cover on the bottom of the unit.



Fig. 1-7

1.4 Interface

As shown in Table 1-3, the unit has eleven connectors: among them, CN3, CN4 and CN5 have a slide-lock mechanism.

Table 1-5 Interface Connectors

Name	Number of pins	Function
CN1	3	AC adapter connection interface
CN2	2	Main battery connection interface
CN3	20	Incorporated microcassette interface
CN4	22	Keyboard interface
CN5	16	LCD interface
CN6	8	High speed serial interface
CN7	8	RS-232C interface
CN8	50	Expansion interface
CN9	3	Bar code reader interface
CN10	3	Analog input interface
CN11	2	External speaker interface

Note: CN5 is integrated on the back of MAPLE board.

Table 1-6 CN1 (AC Adaptor) Pin Assignments

Pin No.	Signal name	Definition
1	VCH	Charging voltage
2	—	Undefined
3	GND	Ground

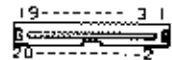

Table 1-7 CN2 (Battery Connection) Pin Assignments

Pin No.	Signal Name	Definition
1	VB	Main battery voltage
2	GND	Ground

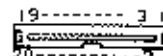

Table 1-8 CN3 (Incorporated Microcassette) Pin Assignments



Pin No.	Signal Name	Definition
1	VLSW	Circuit voltage supply (through read gate)
2	VLR	Circuit voltage supply (read amp. power supply)
3, 4	GND	Ground
5	RDSP	Sound output of read data
6	WE	
7	RDMC	Read signal
8	WD	Write data
9	HMT	Head pinch motor control
10	CNTR	Counter
11	MT B	Capstan motor drive control
12	MT A	Capstan motor drive control
13	HSW	Head switch status
14	MT C	Capstan motor speed control
15, 16	VBSW	Battery voltage supply (for motor)
17	ERAH	Erase signal
18, 19, 20	GND	Ground

Table 1-8 CN3 (Incorporated Microcassette) Pin Assignments



Pin No.	Signal Name	Definition
1	VLSW	Circuit voltage supply (through read gate)
2	VLR	Circuit voltage supply (read amp. power supply)
3, 4	GND	Ground
5	RDSP	Sound output of read data
6	WE	
7	RDMC	Read signal
8	WD	Write data
9	HMT	Head pinch motor control
10	CNTR	Counter
11	MT B	Capstan motor drive control
12	MT A	Capstan motor drive control
13	HSW	Head switch status
14	MT C	Capstan motor speed control
15, 16	VBSW	Battery voltage supply (for motor)
17	ERAH	Erase signal
18, 19, 20	GND	Ground

Table 1-9 CN4 (Keyboard Interface) Pin Assignments

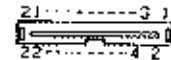

Pin No.	Signal Name	Definition
1	KSC 0	Key scan signal
2	KSC 1	Key scan signal
3	KSC 2	Key scan signal
4	KSC 3	Key scan signal
5	KSC 4	Key scan signal
6	KSC 5	Key scan signal
7	KSC 6	Key scan signal
8	KSC 7	Key scan signal
9	KSC 8	Key scan signal
10	KRTN 0	Key return signal
11	KRTN 1	Key return signal
12	KRTN 2	Key return signal
13	KRTN 3	Key return signal
14	KRTN 4	Key return signal
15	KRTN 5	Key return signal
16	KRTN 6	Key return signal
17	KRTN 7	Key return signal
18	LED 0	CAPS LOCK MODE
19	LED 1	NUMERIC MODE
20	LED 2	INSERT MODE
21, 22	GND	Ground

Table 1-10 CN5 (LCD Interface) Pin Connections

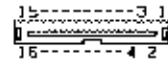

Pin No.	Signal Name	Definition
1	VLD	Circuit voltage: +5
2	YDO	Y data
3	YSCL	Y shift clock
4	YSPU	Speed up signal
5	YDIS	Y display signal
6	FS	Frame signal
7	LP	Latch pulse signal
8	XECL	X enable clock
9	XSCL	X shift clock
10	XD0	X data 0
11	XD1	X data 1
12	XD2	X data 2
13	XD3	X data 3
14	GND	Signal ground
15, 16	VL	Circuit voltage

* View from the rear side of the board.

Table 1-11 CN6 (High Speed Serial Interface) Pin Connections

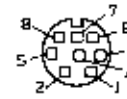

Pin No.	Signal Name	Definition
1	GND	Signal ground
2	$\overline{\text{PTX}}$	Transmit data (output)
3	$\overline{\text{PRX}}$	Receiving data (input)
6	PIN	Receiving mode (input)
7	POUT	Transmit mode (output)
E	FG	Chassis ground

Table 1-12 CN7 (RS-232C Interface) Pin Assignments

Pin No.	Signal Name	Definition
1	GND	Signal ground
2	TXD	Transmit data (output)
3	RXD	Receiving data (input)
4	RST	Request-to-send (output)
5	CTS	Clear-to-send (input)
6	DSR	Data set ready (output)
7	DTR	Data terminal ready (output)
8	CD	Carrier detect
E	FG	Chassis ground

Table 1-13 CN8 (Expansion) Interface



Pin No.	Signal Name	Direction	Definition	Pin No.	Signal Name	Direction	Definition
1	AB12	O	Address bus *2	2	AB11	O	Address bus 11
3	AB14	O	Address bus *4	4	AB13	O	Address bus 13
5	AB 1	O	Address bus 1	6	AB 2	O	Address bus 2
7	AB15	O	Address bus 15	8	AB 0	O	Address bus 0
9	AB 4	O	Address bus 4	10	AB 3	O	Address bus 3
11	AB 6	O	Address bus 6	12	AB 5	O	Address bus 5
13	AB10	O	Address bus 10	14	AB 7	O	Address bus 7
15	AB 8	O	Address bus 8	16	AB 9	O	Address bus 9
17	DB 0	I/O	Data bus 0	18	DB 1	I/O	Data bus 1
19	DB 2	I/O	Data bus 2	20	DB 3	I/O	Data bus 3
21	DB 4	I/O	Data bus 4	22	DB 5	I/O	Data bus 5
23	DB 6	I/O	Data bus 6	24	DB 7	I/O	Data bus 7
25	$\overline{\text{BURQ}}$	O	Bus request	26	$\overline{\text{BUAK}}$	O	Bus acknowledge
27	$\overline{\text{MT}}$	O	Machine cycle 1	28	$\overline{\text{WAIT}}$	I	Wait
29	VL	O	Circuit voltage: +5V	30	$\overline{\text{HLTA}}$	O	Halt acknowledge
31	GND	—	Signal ground	32	GND	—	Signal ground
33	$\overline{\text{RS}}$	O	Reset	34	SPI	I	Speaker
35	$\overline{\text{RD}}$	O	Read	36	$\overline{\text{MRQ}}$	O	Memory request
37	$\overline{\text{WR}}$	O	Write	38	CLK	O	2.45 MHz
39	VCH	O	Charging voltage	40	$\overline{\text{IORQ}}$	O	I/O request
41	DCAS	O	Data CAS	42	DW	O	Data write
43	$\overline{\text{INTEX}}$	I	External interruption	44	OFF	O	Initializing signal of IC "BA"
45	$\overline{\text{RXD}}$	I	Serial received data	46	$\overline{\text{TXD}}$	O	Serial send data
47	VB1	O	Battery voltage	48	BK2	I	Bank exchange
49	CG	—	Chassis ground	50	CG	—	Chassis ground

Table 1-14 CN9 (Bar Code Read Interface) Pin Assignments

Pin No.	Signal name	Definition
1	G	Signal ground
2	+5	Circuit voltage
3	BADT	Bar code reader data

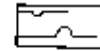
**Table 1-15 CN10 (Analog Input Interface) Pin Assignments**

Pin No.	Signal name	Definition
1	G	Signal ground
2	ANIN	Analog input
3	TRIG	Analog trigger input

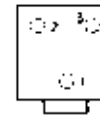
**Table 1-16 CN11 (External Speaker Interface) Pin Assignments**

Pin No.	Signal name	Definition
1	EXSPG	Speaker ground
2	EXSP	Speaker signal

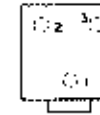

1.5 Connection Cable (option)

Fig. 1-8 shows in a diagram the information cables for all the available peripheral devices.

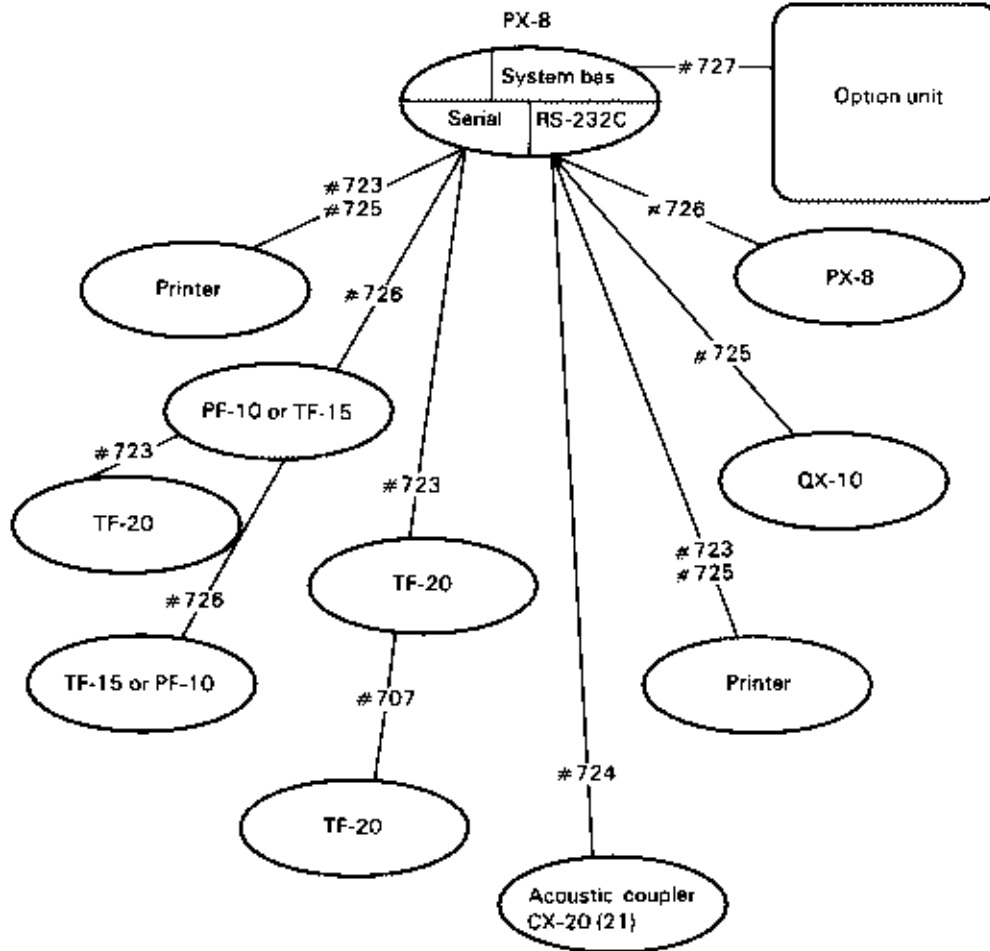

Fig. 1-8 Peripheral Device Information Cables

Table 1-17 Information Cables Specific to the PX-8 Computer

No.	Interface	Part No.
# 723	High speed serial	Y204080000 (Y204080400--JAPAN)
# 724	RS-232C	Y204080100 (Y204080500--JAPAN)
# 725	RS-232C	Y204080200 (Y204080600--JAPAN)
# 726	High speed serial/RS-232C	Y204080300 (Y204080700--JAPAN)
# 727	Expansion interface	Y204301000

(1) #723 cable

Usage : Connection to dedicated floppy disk drive

Connector: Round-type miniature, DIN6

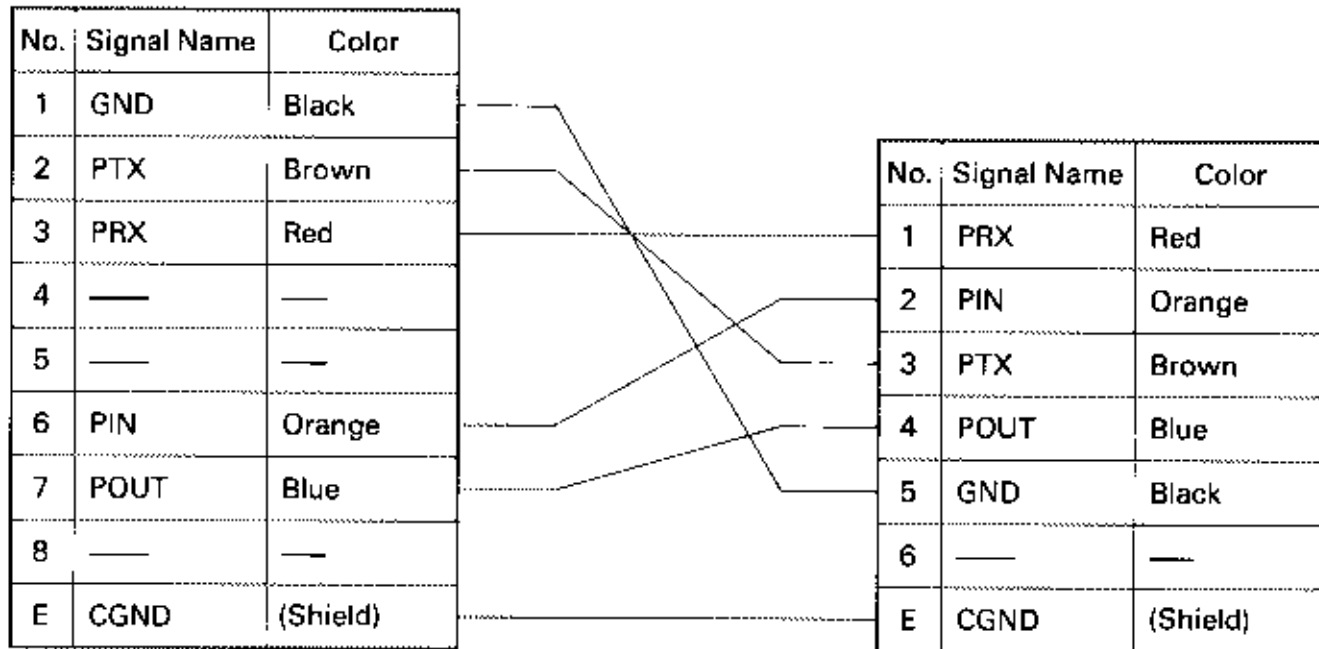
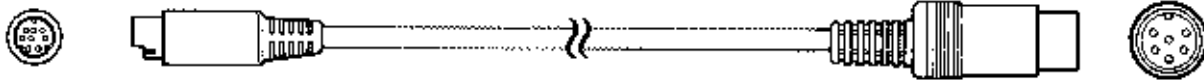
**Fig. 1-9**

#723, simple serial cable, consists of two lines: the send/receive data line and the I/O control line. Therefore, devices which can be connected via this cable are intelligent terminals only (that is, dedicated floppy disk drives) that can be controlled by PIN, POUT.

(2) #724 cable

Usage : Connection to acoustic coupler

Connector: Round-type miniature, DB25

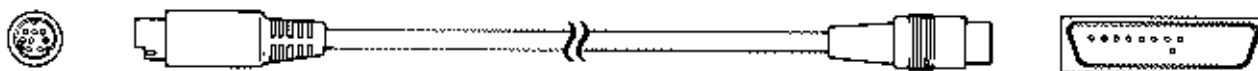

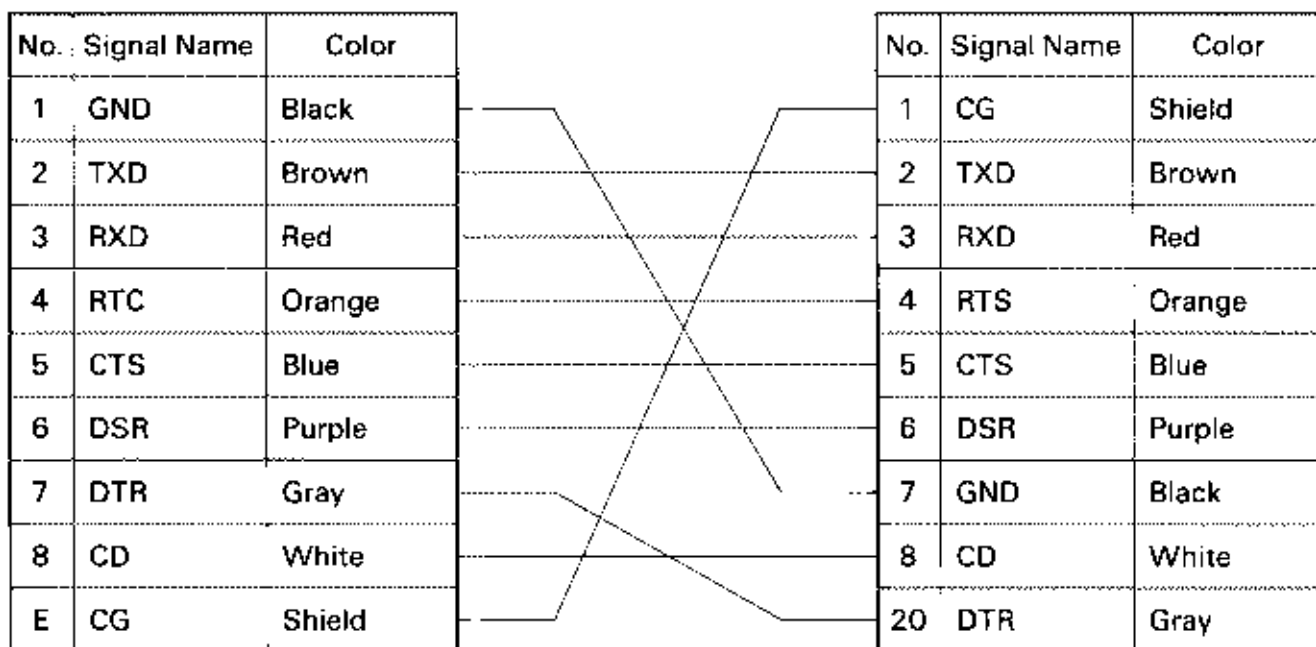

Fig. 1-10

This MODEM connector cable conveys RS-232C interface signals.

(3) # 725 cable

Usage : Connection to printer with RS-232C interface

Connector: Round-type miniature, DB25

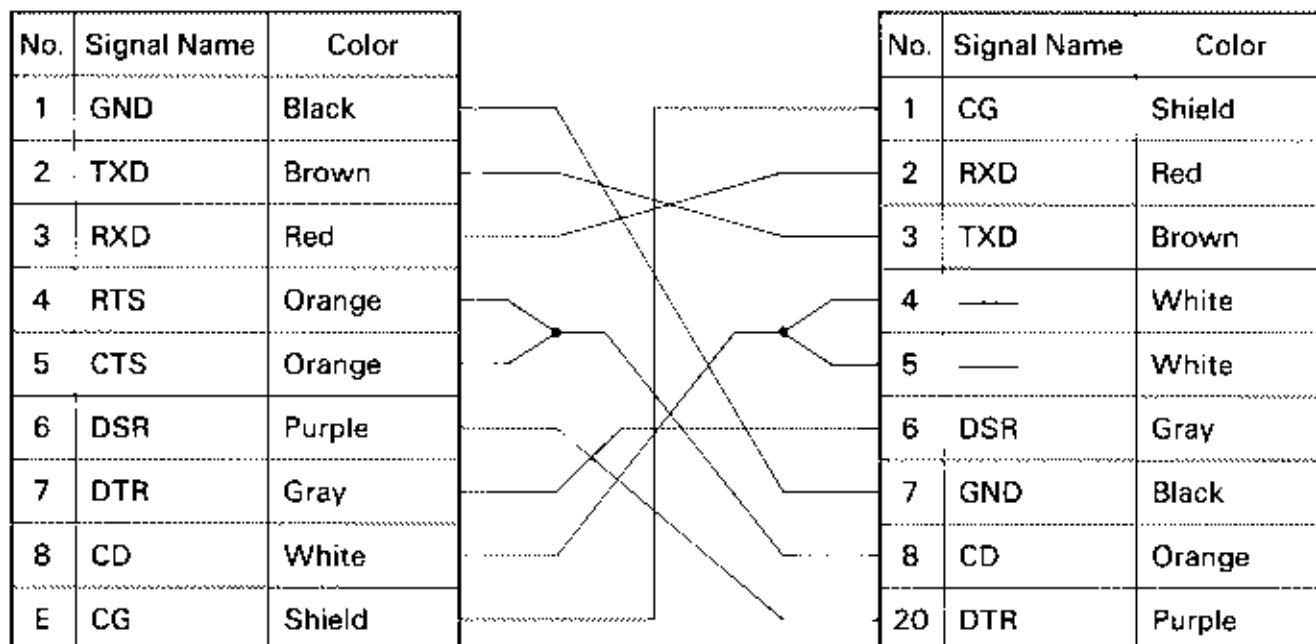
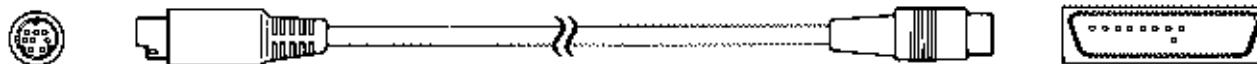

Fig. 1-11

(4) # 726 cable

Usage : Connection between two units or more

Connector: Round-type miniature Round-type miniature

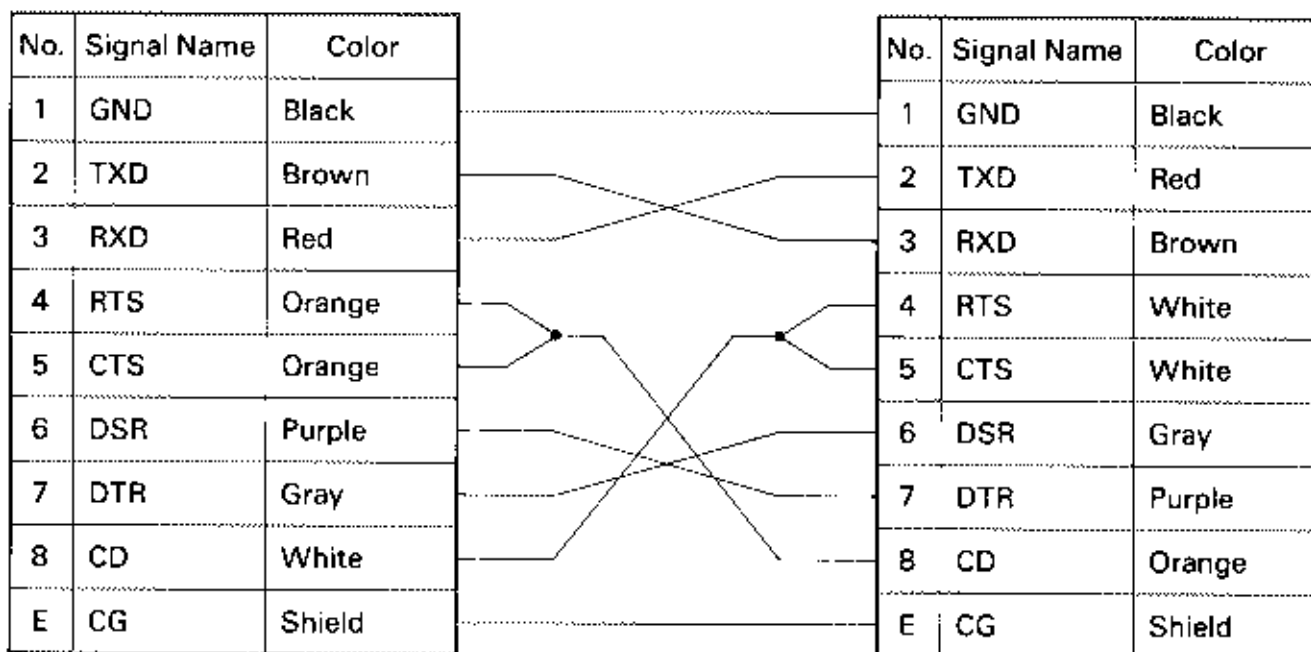
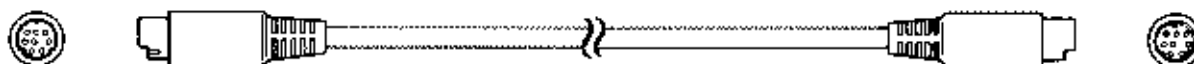

Fig. 1-12

As shown in Fig. 1-11, control lines of DSR and DTR, and connected lines of CTS and RTS (connected to CD) are crossing respectively. Therefore, when transmitting data or receiving, both units must open RS-232C interfaces.

(5) # 727 cable

Usage : Connection to optional unit

Connector: ERC-AA50 - 30 (S)

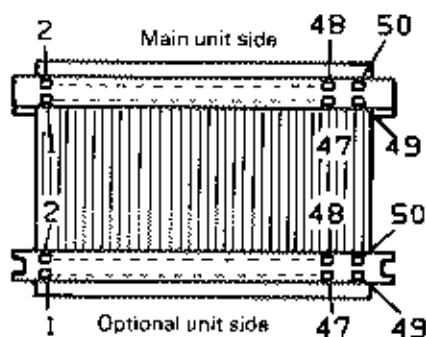
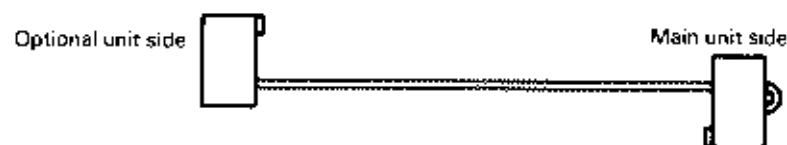

See Page 1-13 CN8 for signals.