

**Radio Shack®**

**TRS-80®  
Model 12  
Owner's Manual**

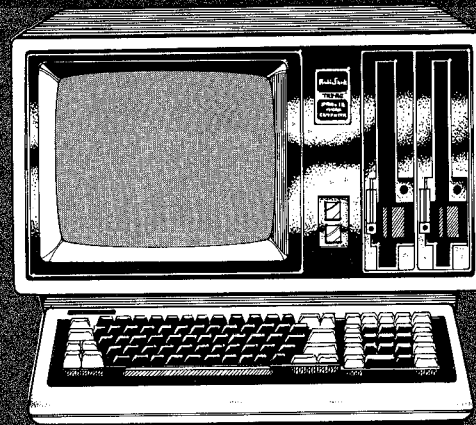

# Important!

## Model 12 Power-Up Sequence

Before powering up your TRS-80 System, be sure the Computer is connected to a three-prong, grounded outlet or grounded power strip (such as Radio Shack's Plug-In Power Strip, Catalog Number 61-2619). If you do not correctly connect and ground the Computer, you're exposing yourself to the danger of electrical shock as well as endangering your Computer and data.

**Special Note for Eight Meg Drive Owners:** If you have a multiple hard disk system, be sure Drive 4 is turned ON first or data may be lost or destroyed.

1. Be sure all floppy diskette drives are empty and all system components are turned OFF.
2. If you have a hard disk system, turn Drive 4 (the primary drive) ON.  
Eight Meg Drive Owners: Turn all secondary hard disk drives (Drives 5-7) ON.
3. Allow one minute warm-up for the disk drives.
4. Turn your Computer ON.
5. Turn all peripherals (including floppy disk expansion unit and printers) ON.

If your operating system is stored on floppy diskette and the Computer has not been modified for hard disk, the Computer will go to Drive 0 and load the operating system. You can then begin using your TRS-80 System as described in your Computer's owner's manual.

If your operating system is stored on hard disk, the Computer will go to Drive 4 and automatically load the operating system. You can then begin using your TRS-80 System as described in your Computer's owner's manual.

If your Computer has been modified for hard disk but you wish to power-up under floppy diskette control (Drive 0), press the key-combination of **REPEAT** **BREAK** or **REPEAT** **ESC** when the screen "whites-out." The Computer will then search Drive 0 for an operating system.

When turning the power OFF.....

**Special Note for Eight Meg Drive Owners:** With multiple hard disk systems, always be sure Drive 4 (the primary drive) is the last disk drive turned OFF. If Drive 4 is not the last drive turned off, data may be lost or destroyed.

1. Turn all peripherals (including floppy disk drives) OFF.  
Eight Meg Drive Owners: Turn all secondary hard disk drives OFF.
2. Turn the primary drive (Drive 4) OFF.
3. Turn the Computer OFF.

Thank you

**Radio Shack**  
A DIVISION OF TANDY CORPORATION

8759205-1082

TERMS AND CONDITIONS OF SALE AND LICENSE OF RADIO SHACK COMPUTER EQUIPMENT AND SOFTWARE  
PURCHASED FROM A RADIO SHACK COMPANY-OWNED COMPUTER CENTER, RETAIL STORE OR FROM A  
RADIO SHACK FRANCHISEE OR DEALER AT ITS AUTHORIZED LOCATION

## LIMITED WARRANTY

### I. CUSTOMER OBLIGATIONS

- A. CUSTOMER assumes full responsibility that this Radio Shack computer hardware purchased (the "Equipment"), and any copies of Radio Shack software included with the Equipment or licensed separately (the "Software") meets the specifications, capacity, capabilities, versatility, and other requirements of CUSTOMER.
- B. CUSTOMER assumes full responsibility for the condition and effectiveness of the operating environment in which the Equipment and Software are to function, and for its installation.

### II. RADIO SHACK LIMITED WARRANTIES AND CONDITIONS OF SALE

- A. For a period of ninety (90) calendar days from the date of the Radio Shack sales document received upon purchase of the Equipment, RADIO SHACK warrants to the original CUSTOMER that the Equipment and the medium upon which the Software is stored is free from manufacturing defects. THIS WARRANTY IS ONLY APPLICABLE TO PURCHASES OF RADIO SHACK EQUIPMENT BY THE ORIGINAL CUSTOMER FROM RADIO SHACK COMPANY-OWNED COMPUTER CENTERS, RETAIL STORES AND FROM RADIO SHACK FRANCHISEES AND DEALERS AT ITS AUTHORIZED LOCATION. The warranty is void if the Equipment's case or cabinet has been opened, or if the Equipment or Software has been subjected to improper or abnormal use. If a manufacturing defect is discovered during the stated warranty period, the defective Equipment must be returned to a Radio Shack Computer Center, a Radio Shack retail store, participating Radio Shack franchisee or Radio Shack dealer for repair, along with a copy of the sales document or lease agreement. The original CUSTOMER'S sole and exclusive remedy in the event of a defect is limited to the correction of the defect by repair, replacement, or refund of the purchase price, at RADIO SHACK'S election and sole expense. RADIO SHACK has no obligation to replace or repair expendable items.
- B. RADIO SHACK makes no warranty as to the design, capability, capacity, or suitability for use of the Software, except as provided in this paragraph. Software is licensed on an "AS IS" basis, without warranty. The original CUSTOMER'S exclusive remedy, in the event of a Software manufacturing defect, is its repair or replacement within thirty (30) calendar days of the date of the Radio Shack sales document received upon license of the Software. The defective Software shall be returned to a Radio Shack Computer Center, a Radio Shack retail store, participating Radio Shack franchisee or Radio Shack dealer along with the sales document.
- C. Except as provided herein no employee, agent, franchisee, dealer or other person is authorized to give any warranties of any nature on behalf of RADIO SHACK.
- D. Except as provided herein, **RADIO SHACK MAKES NO WARRANTIES, INCLUDING WARRANTIES OF MERCHANTABILITY OR FITNESS FOR A PARTICULAR PURPOSE.**
- E. Some states do not allow limitations on how long an implied warranty lasts, so the above limitation(s) may not apply to CUSTOMER.

### III. LIMITATION OF LIABILITY

- A. EXCEPT AS PROVIDED HEREIN, RADIO SHACK SHALL HAVE NO LIABILITY OR RESPONSIBILITY TO CUSTOMER OR ANY OTHER PERSON OR ENTITY WITH RESPECT TO ANY LIABILITY, LOSS OR DAMAGE CAUSED OR ALLEGED TO BE CAUSED DIRECTLY OR INDIRECTLY BY "EQUIPMENT" OR "SOFTWARE" SOLD, LEASED, LICENSED OR FURNISHED BY RADIO SHACK, INCLUDING, BUT NOT LIMITED TO, ANY INTERRUPTION OF SERVICE, LOSS OF BUSINESS OR ANTICIPATORY PROFITS OR CONSEQUENTIAL DAMAGES RESULTING FROM THE USE OR OPERATION OF THE "EQUIPMENT" OR "SOFTWARE". IN NO EVENT SHALL RADIO SHACK BE LIABLE FOR LOSS OF PROFITS, OR ANY INDIRECT, SPECIAL, OR CONSEQUENTIAL DAMAGES ARISING OUT OF ANY BREACH OF THIS WARRANTY OR IN ANY MANNER ARISING OUT OF OR CONNECTED WITH THE SALE, LEASE, LICENSE, USE OR ANTICIPATED USE OF THE "EQUIPMENT" OR "SOFTWARE".  
NOTWITHSTANDING THE ABOVE LIMITATIONS AND WARRANTIES, RADIO SHACK'S LIABILITY HEREUNDER FOR DAMAGES INCURRED BY CUSTOMER OR OTHERS SHALL NOT EXCEED THE AMOUNT PAID BY CUSTOMER FOR THE PARTICULAR "EQUIPMENT" OR "SOFTWARE" INVOLVED.
- B. RADIO SHACK shall not be liable for any damages caused by delay in delivering or furnishing Equipment and/or Software.
- C. No action arising out of any claimed breach of this Warranty or transactions under this Warranty may be brought more than two (2) years after the cause of action has accrued or more than four (4) years after the date of the Radio Shack sales document for the Equipment or Software, whichever first occurs.
- D. Some states do not allow the limitation or exclusion of incidental or consequential damages, so the above limitation(s) or exclusion(s) may not apply to CUSTOMER.

### IV. RADIO SHACK SOFTWARE LICENSE

RADIO SHACK grants to CUSTOMER a non-exclusive, paid-up license to use the RADIO SHACK Software on **one** computer, subject to the following provisions:

- A. Except as otherwise provided in this Software License, applicable copyright laws shall apply to the Software.
- B. Title to the medium on which the Software is recorded (cassette and/or diskette) or stored (ROM) is transferred to CUSTOMER, but not title to the Software.
- C. CUSTOMER may use Software on one host computer and access that Software through one or more terminals if the Software permits this function.
- D. CUSTOMER shall not use, make, manufacture, or reproduce copies of Software except for use on **one** computer and as is specifically provided in this Software License. Customer is expressly prohibited from disassembling the Software.
- E. CUSTOMER is permitted to make additional copies of the Software **only** for backup or archival purposes or if additional copies are required in the operation of **one** computer with the Software, but only to the extent the Software allows a backup copy to be made. However, for TRSDOS Software, CUSTOMER is permitted to make a limited number of additional copies for CUSTOMER'S own use.
- F. CUSTOMER may resell or distribute unmodified copies of the Software provided CUSTOMER has purchased one copy of the Software for each one sold or distributed. The provisions of this Software License shall also be applicable to third parties receiving copies of the Software from CUSTOMER.
- G. All copyright notices shall be retained on all copies of the Software.

### V. APPLICABILITY OF WARRANTY

- A. The terms and conditions of this Warranty are applicable as between RADIO SHACK and CUSTOMER to either a sale of the Equipment and/or Software License to CUSTOMER or to a transaction whereby RADIO SHACK sells or conveys such Equipment to a third party for lease to CUSTOMER.
- B. The limitations of liability and Warranty provisions herein shall inure to the benefit of RADIO SHACK, the author, owner and/or licensor of the Software and any manufacturer of the Equipment sold by RADIO SHACK.

### VI. STATE LAW RIGHTS

The warranties granted herein give the **original** CUSTOMER specific legal rights, and the **original** CUSTOMER may have other rights which vary from state to state.

## SERVICE POLICY

Radio Shack's nationwide network of service facilities provides quick, convenient, and reliable repair services for all of its computer products, in most instances. Warranty service will be performed in accordance with Radio Shack's Limited Warranty. Non-warranty service will be provided at reasonable parts and labor costs.

Because of the sensitivity of computer equipment, and the problems which can result from improper servicing, the following limitations also apply to the services offered by Radio Shack:

1. If any of the warranty seals on any Radio Shack computer products are broken, Radio Shack reserves the right to refuse to service the equipment or to void any remaining warranty on the equipment.
2. If any Radio Shack computer equipment has been modified so that it is not within manufacturer's specifications, including, but not limited to, the installation of any non-Radio Shack parts, components, or replacement boards, then Radio Shack reserves the right to refuse to service the equipment, void any remaining warranty, remove and replace any non-Radio Shack part found in the equipment, and perform whatever modifications are necessary to return the equipment to original factory manufacturer's specifications.
3. The cost for the labor and parts required to return the Radio Shack computer equipment to original manufacturer's specifications will be charged to the customer in addition to the normal repair charge.

**Warning:** This equipment generates, uses, and can radiate radio frequency energy and if not installed and used in accordance with the instructions manual, may cause interference to radio communications. It has been tested and found to comply with the limits for a Class A computing device pursuant to Subpart J of Part 15 of FCC Rules, which are designed to provide reasonable protection against such interference when operated in a commercial environment. Operation of this equipment in a residential area is likely to cause interference in which case the user at his own expense will be required to take whatever measures may be required to correct the interference.

TRSDOS™ Operating System: Copyright 1982 Tandy Corporation. All Rights Reserved.

TRSDOS™-II Operating System: Copyright 1982 Tandy Corporation. All Rights Reserved.

BASIC Software: Copyright 1980 Microsoft. All Rights Reserved. Licensed to Tandy Corporation.

TRS-80® Model 12 Owner's Manual: Copyright 1982 Tandy Corporation. All Rights Reserved.

Reproduction or use without express written permission from Tandy Corporation, of any portion of this manual is prohibited. While reasonable efforts have been taken in preparation of this manual to assure its accuracy, Tandy Corporation assumes no liability resulting from any errors or omissions in this manual, or from the use of the information obtained herein.

## INTRODUCTION

## The Model 12

Your new TRS-80 Model 12 is a powerful business tool. The Model 12's basic features include:

- 80K bytes of memory: 64K bytes of random access memory and 16K bytes more RAM for use by the operating system
- Thinline drives that enable you to use double-sided diskettes
- Eight programmable function keys
- Compatibility with Radio Shack Model II software
- Green phosphor video display for easy reading
- Detached keyboard for your convenience
- Sound Capability (audible alarm and key-click),

Also, your Model 12 can be expanded -- as your needs grow -- to include hard disks, graphics, a 16-bit microprocessor, and more.

## About This Manual

This manual describes the TRS-80 Model 12. It shows how the Model 12 is installed and operated. It explains how to store information on disks and how to use a few essential operating system commands.

If you are unfamiliar with any terms used in this manual, refer to Appendix C, "Glossary," for their definitions.

## Table of Contents

Introduction	
The Model 12.....	1
About This Manual.....	1
Quick Reference Chart.....	4
Chapter 1: About Your Computer	
About Your Equipment.....	7
Installation.....	13
Power Up/Power Down.....	16
Chapter 2: Backup Copies.....	19
Chapter 3: Sample Session	
Operating Systems and Application Programs.....	27
Storing Information .....	30
Removing and Swapping Diskettes.....	32
Chapter 4: Floppy Diskette System Preparation	
Using TRSDOS-II Application Programs.....	33
Using TRSDOS Application Programs.....	33
Formatting Data Diskettes.....	37
Chapter 5: Hard Disk System Preparation.....	39
Chapter 6: Maintenance	
Taking Care of Your Diskettes.....	41
Drive Maintenance.....	41
Appendices	
A: Backing Up Disks and Files.....	45
B: More About TRSDOS-II.....	57
C: Making a Minimum System Diskette.....	61
D: Glossary.....	65
E: Problems and Error Messages.....	69
F: Specifications.....	81
G: Keyboard Code Map.....	91
Index.....	92

## Quick Reference Chart

## Power Up

1. Primary hard disk
2. Secondary hard disks
3. Display console
4. Peripherals

## Power Down

1. Peripherals
2. Secondary hard disks
3. Primary hard disk
4. Display console

## Commands

In the commands below, the underlined text indicates a value or values that you must supply.

**BACKUP** drive1 TO drive2 {options} -- Duplicates the diskette in drive1 onto the diskette in drive2.

**COPY** filespec1 TO filespec2 {option} -- Copies filespec1 and names the new file filespec2. To copy from one diskette to another using one drive, specify the diskette name and the drive number in filespec1 and filespec2.

**COPY** filespec TO drive {option} -- Copies filespec to the disk in drive, giving the new file the same name as filespec.

**DIR** drive {options} -- Displays the directory of user files in the specified drive.

**DRIVE** drive {options} -- Sets the specified drive for its most efficient use.

**FCOPY** source TO drive {options} -- Transfers the TRSDOS file(s) from the source to drive, a TRSDOS-II disk.

**FCOPY** filespec1 TO filespec2 {option} -- Transfers TRSDOS filespec1 to a TRSDOS-II disk, naming the new file filespec2.



**FORMAT** drive {options} -- Organizes the diskette in the specified drive (while erasing any information it contains).

**HELP** subject -- Displays information about the TRSDOS-II subject. If the subject is a TRSDOS-II command, the command syntax is displayed. If help is not available for the specified subject, or if you omit the subject, a list of commands and subjects for which help is available is displayed with a brief description of each.

**KILL** filespec -- Deletes a file and frees the space it occupied.

**MOVE** source TO destination {options} -- Copies one or more user files from the source to the destination.

**RESTORE** source TO destination -- Copies compressed data from the source diskette and restores it in TRSDOS-II format on the destination drive. See "SAVE."

**SAVE** source TO destination -- Copies data from the source drive and stores it in compressed form on the destination diskette. The only way to access saved data is through RESTORE.

## Chapter 1: ABOUT YOUR COMPUTER

Carefully unpack your Model 12. Save the packing materials in case you need to move the Computer. Make sure you have the following items:

- Display console
- Keyboard
- Power cord
- TRSDOS-II Reference Manual
- BASIC Reference Manual
- TRSDOS-II System Diskette and BASIC Interpreter
- TRSDOS System Diskette and BASIC Interpreter

### About Your Equipment

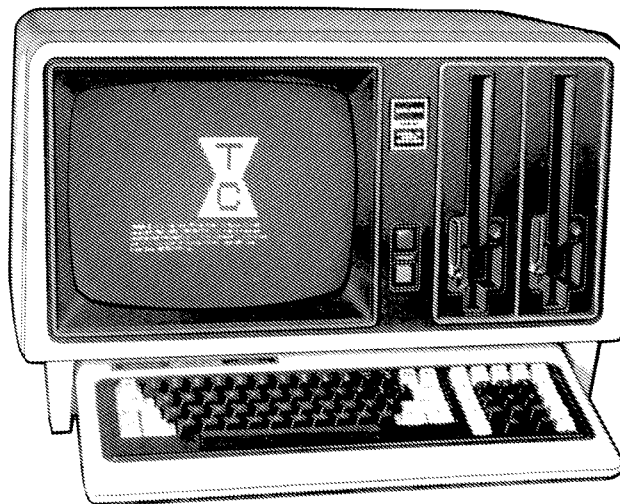

Model 12 Computer

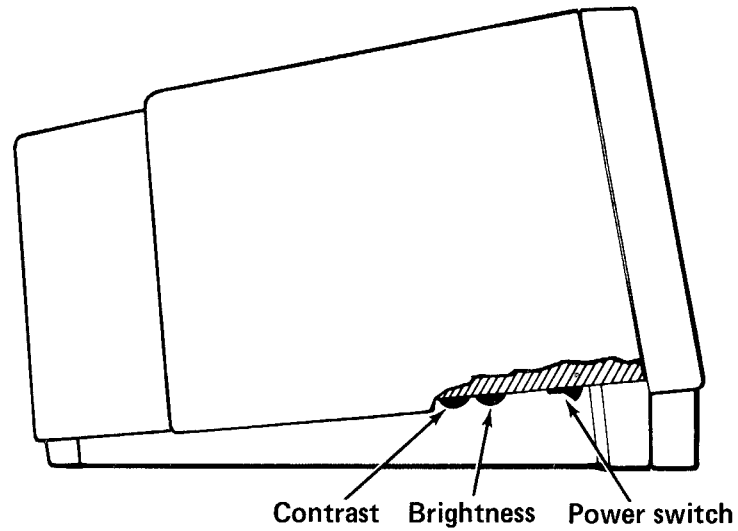

Power Switch, Brightness and Contrast Controls.

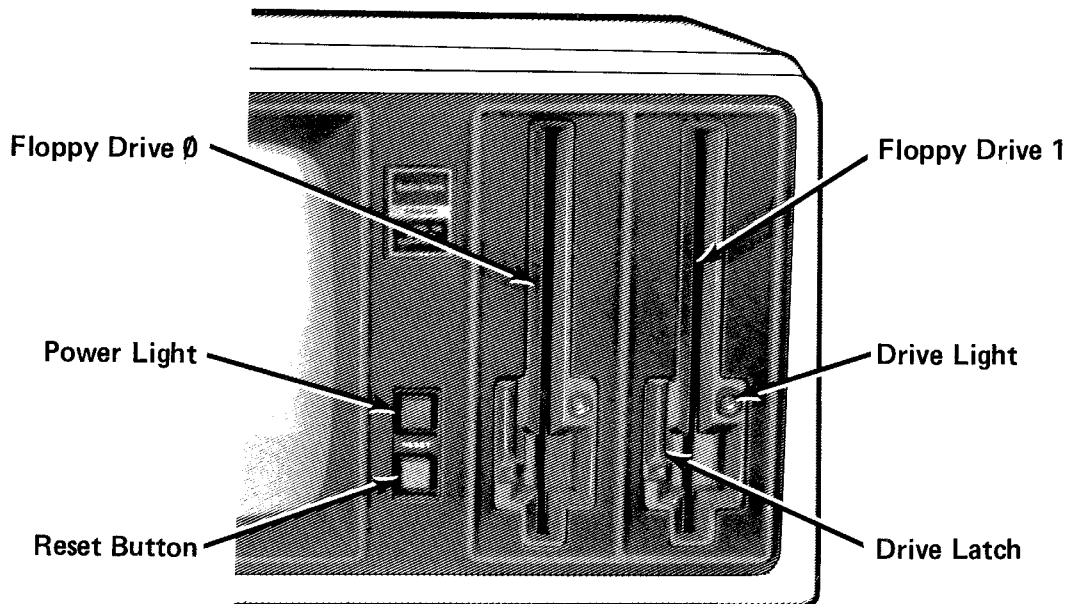

**Reset Button** -- Repeats the power-up sequence.

**Power Light** -- Lighted when the computer's power is on.

**Drive Light** -- Never remove a diskette when the drive light is on.

### Inserting a Diskette

1. Carefully insert a diskette into a drive as illustrated. Push the diskette into the slot until it locks into place.

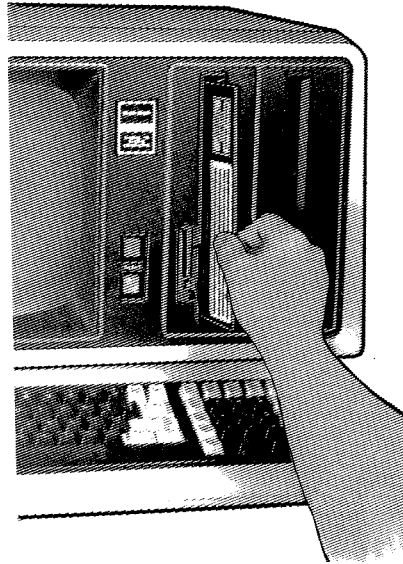

2. Rotate the drive latch clockwise until it locks into a horizontal position.

**Important** Never turn your computer on or off while a diskette is in a drive. This can destroy data stored on the diskette.

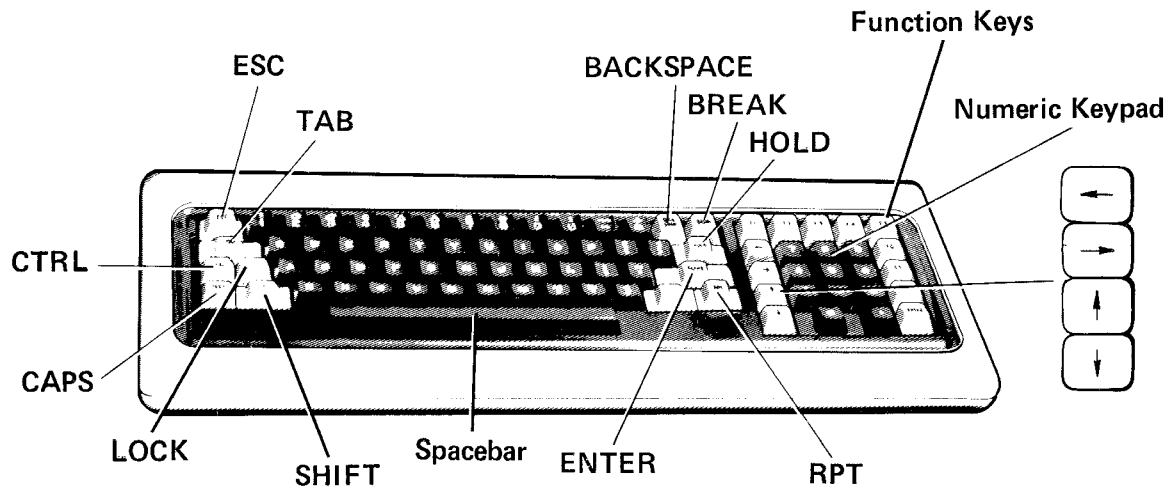

Model 12 Keyboard.

**<CAPS>** -- When the <CAPS> light is on, <CAPS> sends only capital-letter codes for the alphabet keys. It does not affect other keys. Press <CAPS> once to turn the caps-only mode off or on.

**<SHIFT>, <LOCK>** -- Lets you input capital letters and shift punctuation symbols. Hold down <SHIFT> while pressing the desired key or press <LOCK> once (the red light comes on). When the <LOCK> light is on, only shifted characters are output. To release <LOCK>, press <SHIFT>.

**Numeric Keypad** -- These keys are not affected by <SHIFT>, <LOCK>, or <CAPS>.

**<RPT>** -- Repeats a character continuously when held down at the same time as another key.

The uses of the following keys vary depending on the program or operating system in use. Typical uses are described below.

- <TAB> -- Moves the cursor forward one tab position. Positions usually are preset at intervals of eight spaces.
- <BACKSPACE> -- Moves the cursor back one character position, while canceling the last character typed.
- <BREAK> -- Interrupts the task in progress. Returns the Computer to the command level.
- <HOLD> -- Temporarily stops program execution. Press <HOLD> again to continue execution.
- <ENTER> -- Functions like the carriage return on a typewriter, but only the characters to the left of the cursor are used. The other characters are deleted.
- Spacebar -- Enters a space and moves the cursor forward one character position.
- <↑> <↓> <←> <→> -- Moves the cursor one character position or one line in the indicated direction.
- <CTRL> & <KEY>, <ESC>, and Function Keys -- The tasks performed by these keys are determined by the program or operating system in use.

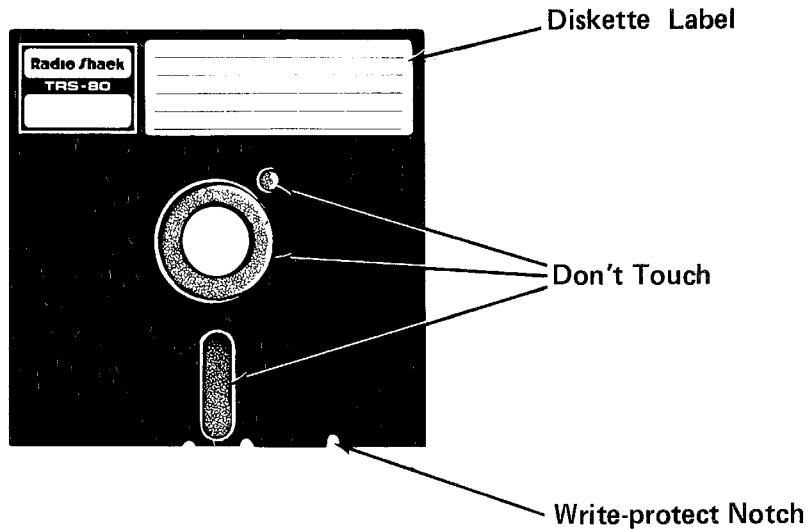

Floppy Diskette. Diskettes are used for data and program storage. Keep them away from dirt, pressure, magnetic fields, and excessive heat and sunlight. Don't bend them.

**Label** -- After placing a label on a diskette, write on it with a felt-tip pen only.

**Write-Protect Notch** -- To change information on a diskette, you must write enable the diskette. Do this by covering the write-protect notch with one of the tabs provided. You cannot change a diskette's information if the write-protect notch is uncovered.

### Optional Equipment

Visit your Radio Shack Computer Center to learn about the other equipment you can use with the Model 12. If you have peripheral equipment, such as a hard disk or printer, follow the instructions in the manual supplied with the equipment.

## Installation

Improperly connecting or grounding the Computer exposes you to the danger of electrical shock. It also endangers your Computer and data. Follow these installation instructions carefully.

1. Place your Model 12 near a grounded, 120 VAC, 3-prong outlet that does not power heavy machinery, copiers, or office machines with defective switches.
2. Make sure all equipment is turned off.
3. Connect the keyboard's built-in cable to the display console.

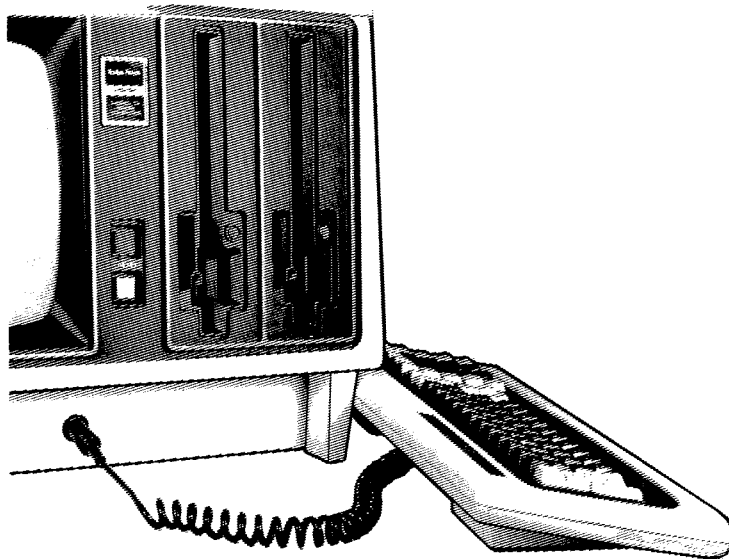



4. Connect the power cord to the display console.

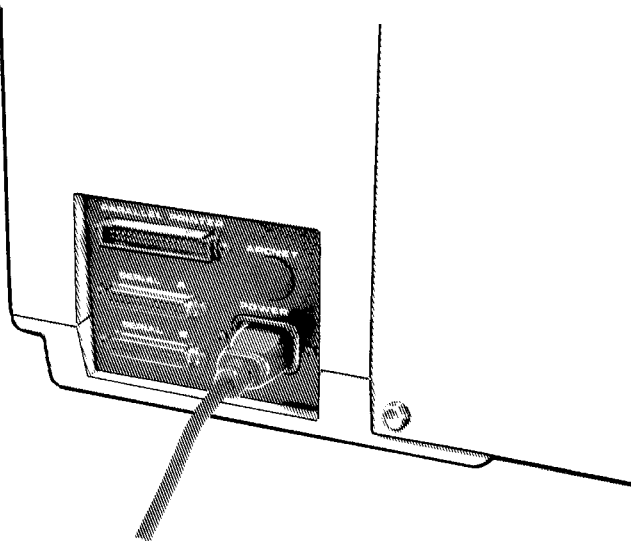

5. Plug the power cord directly into the outlet specified in Step 1.

### Installing Peripheral Equipment

You can use other Radio Shack equipment (such as a printer or floppy diskette expansion unit) with your Model 12. To install such equipment, refer to the following illustrations and to the manual(s) supplied with the equipment.

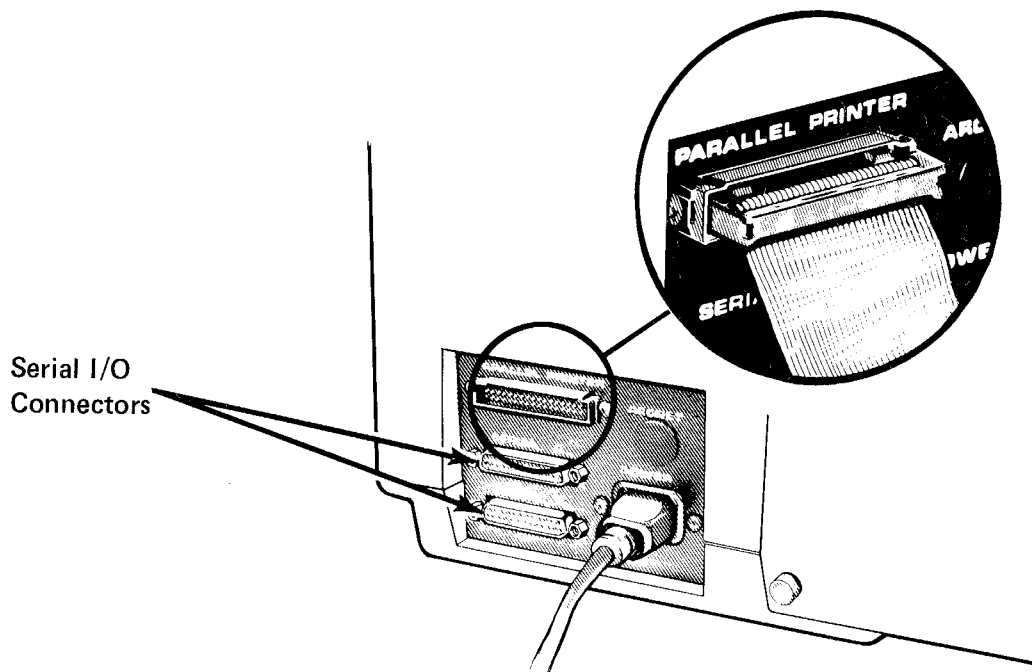

Model 12 External Peripheral Equipment Connections.

**Parallel Printer Connector** -- to connect Radio Shack parallel printers to your Model 12. When connecting the printer cable, make sure the cable exits the bottom of the connector (shown above).

**Serial I/O Connectors** -- to install serial equipment such as serial line printers, modems, and data terminals. When connecting a DB-25 type cable, fit the cable connector to your Model 12's connector.

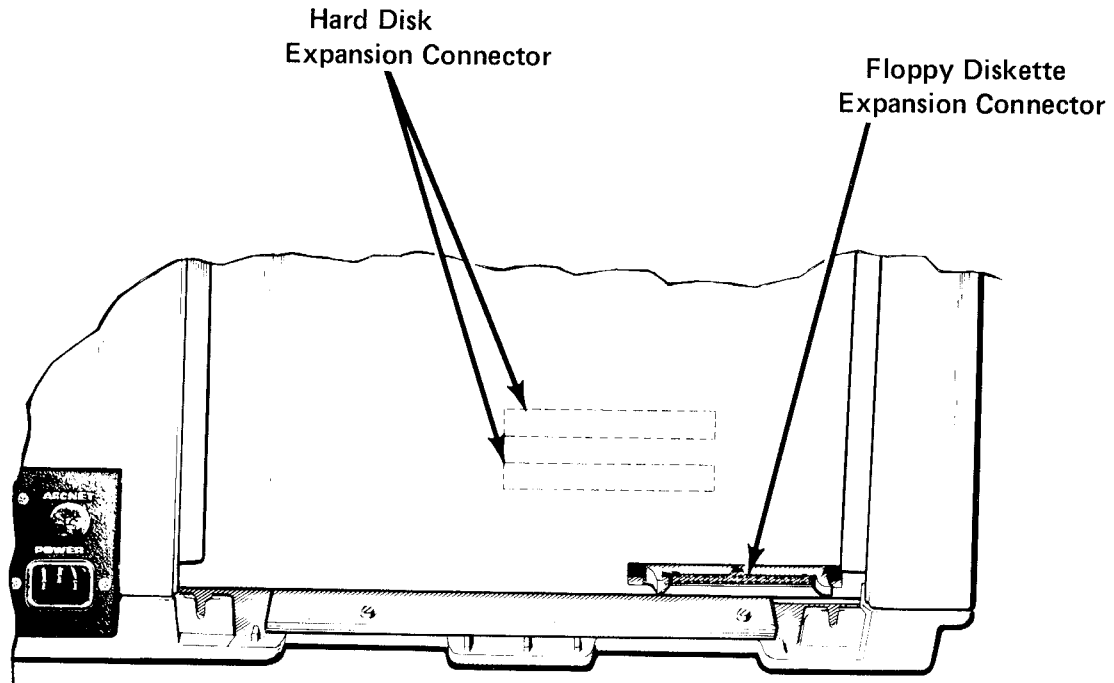

Model 12 Internal Peripheral Equipment Connections.  
(view with access panel removed)

**Floppy Diskette Expansion Connector** -- to add floppy diskette storage devices, such as the Thinline Disk Bay. Instructions for connecting cables are on the next page.

**Hard Disk Expansion Connector** -- to add hard disk storage devices. Only computers that are modified for hard disk have this connector. It is located in one of the slots shown in the illustration above. Instructions for connecting the cables are on the next page.

**Note:** The floppy diskette and hard disk expansion connectors are behind the Input/Output Access Panel on the back of the Model 12. You can open the access panel by removing the "thumbscrews" at the bottom of the panel.

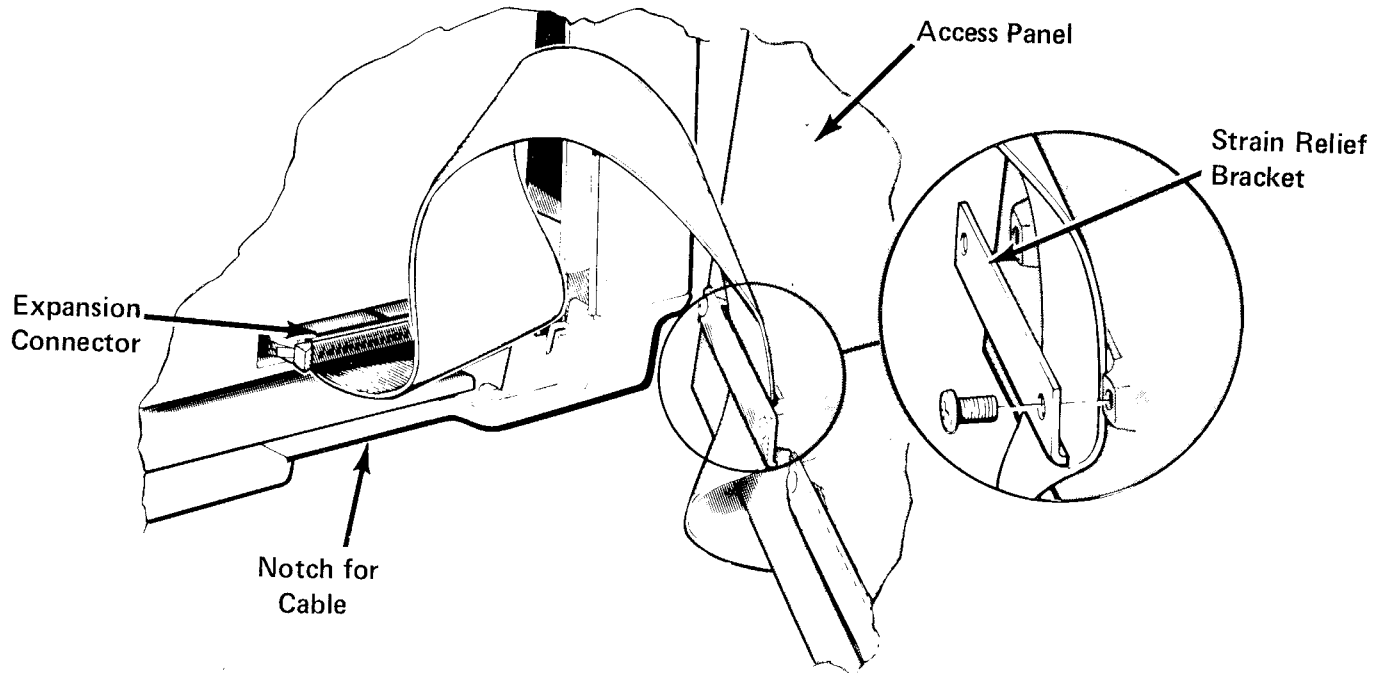

### Internal Cable Connections

1. Remove the access panel by loosening the thumbscrews at the bottom of the panel.
2. Attach the cable that is included with your expansion unit to the appropriate connector (floppy or hard). Position the connector so the cable exits the bottom.
3. Remove from the access panel the "strain relief bracket" nearest to the connector.
4. Run the cable downward through the strain relief, leaving about 8 inches of cable between the strain relief and the expansion connector.
5. Replace the strain relief bracket and run the cable through the notch in the computer base.
6. Replace the access panel and tighten the thumbscrews.

### Power Up/Power Down

Always turn your Model 12 on and off exactly as described in this section. Any change in the sequences might damage the computer and data.

If your computer is modified for hard disk, you can use it in two ways: under hard disk control or under floppy diskette control. Because hard disk operation is more efficient, you'll probably operate under hard disk control most of the time. If you have initialized your hard disks and wish to power up under hard disk control, refer to your Hard Disk Owner's Manual.

Until you have initialized your hard disk(s) as instructed in your Hard Disk Owner's Manual, you must operate under floppy diskette control.

#### Powering Up the Model 12

1. Make sure all diskette drives are empty and all equipment is off.

If you want to operate under hard disk control, and your computer is modified for hard disk, turn on the primary hard disk unit (Drive 4) **first**. Then turn on the secondary hard disk unit(s).

2. Turn on the Computer (display console power switch).
3. Turn on any peripheral equipment.

If you want to operate under floppy diskette control and your computer is modified for hard disk, press <RPT><BREAK> during the "white-out" of the video display. The message "INSERT DISKETTE" is displayed to indicate that you are operating under floppy diskette control.

If INSERT DISKETTE doesn't appear or the hard disk operating system doesn't load:

- . Press the reset button
- . If your computer is modified for hard disk, press the reset button and then press <RPT><BREAK> again
- . Adjust the brightness and contrast controls
- . Turn off the Computer and check all connections
- . See Appendix D, "Problems and Error Messages"

#### Powering Down a Floppy Disk Model 12

1. Make sure all the floppy drives are empty.
2. Turn off all peripheral equipment except hard disk drives.

Hard Disk Users: Turn off all secondary hard disk units. Then turn off the primary hard disk unit.

3. Turn off the Computer.

### Loading TRSDOS-II From Floppy Diskette

To load TRSDOS-II from floppy diskette, follow these steps:

1. Power up your computer as previously described.

Note: If your system is modified for hard disk, press <RPT><BREAK> until the message "INSERT DISKETTE" appears. If the message does not appear, press RESET and try again.

2. Insert a TRSDOS-II system diskette into Drive 0.
3. Your screen should show a startup message similar to the following:

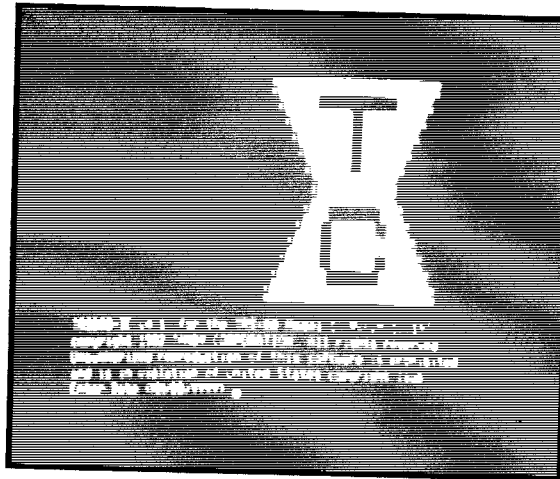

4. If, instead of a startup message:
  - The INSERT DISKETTE message remains or no message is displayed, the diskette is probably in backwards. Remove the diskette and correctly insert into Drive 0 a diskette containing an operating system. Press the reset button.
  - NOT A SYSTEM DISKETTE  
RE-BOOT is displayed, remove the diskette. Correctly insert an operating system diskette into Drive 0. Press the reset button.
  - ERROR is displayed, power down your system and try again. If the message occurs again, see Appendix D, "Problems and Error Messages."

## Chapter 2: BACKUP COPIES

Sometimes information stored on disk is lost. This problem can result from:

- . Worn-out or mishandled disks
- . Mishandled equipment
- . The power going out while you're using the Computer

That is why it is important to make "backup" copies of all the information you store on disk.

Of the many ways to copy information from a disk, the SAVE and BACKUP commands are used most often.

SAVE usually is used to copy all the information on a hard disk to floppy diskettes. Appendix A, the TRSDOS-II Reference Manual, and your Hard Disk Owner's Manual have information on SAVE.

BACKUP usually is used to copy all the information on one floppy diskette to another. This chapter tells you how to make backups of your TRSDOS-II System Diskette and TRSDOS System Diskette. Appendix A, "Making Backup Copies of Files and Disks" includes instructions on backing up other diskettes, as well.

Use BACKUP now to copy your TRSDOS-II System Diskette and TRSDOS System Diskette.

Note: You must have at least two floppy diskette drives to make a backup of your TRSDOS-II Systems diskette.



### TRSDOS-II System Diskette BACKUP

The TRSDOS-II BACKUP command copies information from one diskette to another. Unlike TRSDOS BACKUP in which you must first format the diskette, TRSDOS-II BACKUP automatically formats the diskette to which the information is being copied ("destination diskette").

To use the TRSDOS-II BACKUP command, you need two floppy diskette drives. To make a backup of your TRSDOS-II System Diskette, use the following steps:

1. Prepare a destination diskette by covering the write-protect notch of a blank diskette with a write-enable tab.
2. Power up or reset the Computer. If you have a hard disk, press <RPT> <BREAK> to operate under floppy diskette control.
3. Insert the TRSDOS-II System Diskette (source diskette) into Drive 0.
4. When prompted, enter the date in mm/dd/yyyy format (for example: 03/19/1982 for March 19, 1982). Press <ENTER> when prompted for the time. TRSDOS-II Ready is displayed.
5. Insert the destination diskette into Drive 1.
6. Type:   BACKUP 0 TO 1 <ENTER>
7. If you are using an old diskette instead of a blank diskette, the following message might appear:

DESTINATION Disk Contains Data. Copy Over It (Y/N)?

If you do not need the data on the diskette, type Y <ENTER>. If you might need the data, type N <ENTER>.

BACKUP displays the following message when the backup is complete:

```
Backup Successfully Completed
Drive 1 Disk ID is: TRSDOS
TRSDOS-II Ready
```

If your screen displays a message that the backup aborted, repeat Steps 5 through 7 using a different destination diskette.

### TRSDOS System Diskette BACKUP

The TRSDOS BACKUP command copies information from one diskette to another. The diskette to which the information is copied ("destination" diskette) must be "formatted." To format a blank diskette and then back up your TRSDOS System diskette, follow these steps:

Note: When making a TRSDOS backup on your Model 12, be sure you have a TRSDOS 2.0b system diskette in Drive 0. The TRSDOS System Diskette contains TRSDOS 2.0b.

To begin making a backup, power up your computer as follows:

1. Prepare a destination diskette by covering the write-protect notch of a blank diskette with a write-enable tab.
2. Power up or reset the Computer. If you have a hard disk, press <RPT> <BREAK> to operate under floppy diskette control.
3. When prompted, insert the TRSDOS System Diskette ("source" diskette) into Drive 0.
4. Enter the date in mm/dd/yyyy format (for example: 03/19/1982 for March 19, 1982). Press <ENTER> when prompted for the time. TRSDOS READY appears.

You are now ready to make a backup of your TRSDOS System Diskette (or any TRSDOS diskette). The instructions given next are divided into two sections. The first is for multi-drive users and the second is for single-drive users.

#### Multi-Drive Users:

5. Insert the destination diskette into Drive 1. Then, at TRSDOS READY, type:

FORMAT 1 <ENTER>

6. The following prompt is displayed on the screen:
- Mount Diskette for Formatting on Drive 1.  
Continue? (Y/Q)
- Since you already have mounted your diskette on Drive 1, type Y <ENTER> to continue.
7. If you are formatting over a used diskette, the following prompt might appear:
- Diskette CONTAINS DATA; Format OVER it? (Y/Q)
- If you do not need the data on the diskette, type Y <ENTER>. If you might need the data, type Q <ENTER>.
8. TRSDOS READY is displayed when the formatting is complete. Type:
- BACKUP Ø TO 1 <ENTER>
- To answer the following questions, type Y <ENTER>:
- Source Diskette Ready? (Y/Q)  
Destination Diskette Ready? (Y/Q)
9. When the question:
- Change diskette information?..
- appears, type N <ENTER>.
10. TRSDOS READY is displayed when the backup is complete. If your screen displays a message that the backup aborted, try again, using a different destination diskette.

**Single-Drive Users:**

5. At TRSDOS READY, type: `FORMAT Ø <ENTER>`

When the message:

Mount Diskette for Formatting on Drive Ø  
Continue? (Y/Q)

appears, insert the destination diskette into Drive Ø.  
Type Y <ENTER> to continue.

6. The following message is displayed when the formatting is complete:

Insert SYSTEM diskette Press ANY key to continue

Remove the formatted destination diskette and place the TRSDOS System Diskette in Drive Ø.

7. At TRSDOS READY, type: `BACKUP Ø TO Ø <ENTER>`

8. Answer Y <ENTER> to the following question:

Source Diskette Ready? (Y/Q)

9. When the question:

Change diskette information?..

is displayed, type N <ENTER>.

10. When the message:

Insert DESTINATION diskette Press ANY key to continue

appears, remove the TRSDOS System Diskette and insert the destination diskette into Drive Ø. Press <ENTER> and the backup continues.

You will be alternately prompted to insert the source diskette (TRSDOS System Diskette) and the destination diskette.

## 11. When the message

Insert SYSTEM diskette Press ANY key to continue appears, the backup is complete. Remove the destination diskette and insert the TRSDOS System Diskette into Drive Ø. Press <ENTER> and TRSDOS READY is displayed.

### Tips on Safeguarding Data

To ensure the safety of your data and programs:

- Store all original operating system and application program diskettes in a safe place
- Run the Computer with copies of your original TRSDOS-II System Diskette, TRSDOS System Diskette, and application program diskettes
- Every time you create or update a file, copy it to another diskette or make a backup of the diskette.
- Take proper care of your Computer and disks as instructed in Chapter 6, "Maintenance"

Accidents happen, so think about how much time, effort, and money could be lost if you decide not to make backup copies.

### Chapter 3: SAMPLE SESSION

This chapter is an introduction to operating systems, application programs, computer memory, and disk storage. If you are familiar with these topics, you might want to skim or skip this chapter. If you are not familiar with them, learn as you try the examples in this chapter. Practice the entire session, doing the samples in order. The session takes about half an hour.

#### Operating Systems and Application Programs

An **operating system** is a program that enables you to operate a computer. It lets you manipulate and store data, control peripherals, and use application programs.

The Model 12's operating system is TRSDOS-II. Your Computer may also use the TRSDOS system (Version 2.0b).

TRSDOS-II is a greatly enhanced version of TRSDOS. It is especially designed for our newer computers and is the same software used with the hard disk. It contains many new features, commands and utilities. It also allows you to use the key-click and audible alarm features of your Model 12.

TRSDOS is the operating system originally designed for the TRS-80 Model II. It comes on the diskette labeled "TRSDOS System Diskette". A file called THINLINE is included on this diskette, which allows you to patch your TRSDOS application diskettes to run on your Model 12 thinline drives.

When running application programs, keep an operating system disk in your primary drive (Drive 0 for floppy diskette operation or Drive 4 for hard disk operation). However, be sure to remove all floppy diskettes from their drives before turning on or off your computer.

To start up with TRSDOS-II, use the following steps:

1. Power up your Model 12. If you have a hard disk system, press <RPT> <BREAK> until INSERT DISKETTE appears.
2. Insert a backup of the TRSDOS-II System Diskette into Drive 0. If you have only one floppy diskette drive, use the original TRSDOS-II System Diskette.
3. Enter today's date in the format displayed on your screen. For example, for August 23, 1983, type:  
  
08/23/1983 <ENTER>
4. To skip the ENTER TIME prompt now on your screen, press <ENTER>. This starts the time at 00.00.00. Or, enter the time in the displayed, 24-hour format (seconds are optional). For example, for 2:30 p.m., type:

14.30 <ENTER>

Your screen shows:

TRSDOS-II Ready

.....

This message indicates that TRSDOS-II is ready to accept a command.

Notice that TRSDOS-II powers up with key-click turned on. That is, each time you press a key, the computer generates a click. To turn the key-click off, type CLICK OFF and press <ENTER>.

**Application programs** help you perform tasks such as bookkeeping, word processing, and program development. The BASIC Interpreter is an application program that lets you write your own programs in BASIC. The BASIC Interpreter program is on your TRSDOS-II diskette.



5. To load the BASIC interpreter, type: BASIC <ENTER>

BASIC displays its startup message and:

```
Ready
>
```

Ready > indicates that BASIC, not TRSDOS-II, is ready to accept a command or program statement.

You cannot use TRSDOS-II and an application program, such as BASIC, at the same time. For example, if you type a TRSDOS-II command while BASIC is controlling the Computer, an error message is displayed. The application program does not understand the command, and TRSDOS-II did not receive the command.

6. Type the TRSDOS-II DIR command: DIR <ENTER>

Your screen shows:

```
?SN Error
Ready
>
```

?SN ERROR indicates that BASIC doesn't understand the TRSDOS-II command. (You can execute a TRSDOS-II command from BASIC via the SYSTEM command described in the BASIC Reference Manual.)

7. Try writing a BASIC program by typing the following:

```
10 CLS <ENTER>
20 PRINT "HELLO" <ENTER>
```

If you type a line incorrectly, press <ENTER> and type it correctly.

8. Test the program by typing BASIC's RUN command:

```
RUN <ENTER>
```

Your screen should show:

```
HELLO
Ready
>
```

## Storing Information

Computers store information in two ways:

- . Temporarily, in memory (while the computer is on)
- . Permanently, in a storage device

The "Hello" program you typed is stored in memory. You can run it whenever you wish until you exit the BASIC program (TRSDOS-II resumes control). If you want to keep the program to run later, you must store it permanently before exiting BASIC. Your Computer uses floppy diskettes and hard disks as storage devices.

1. To save the "Hello" program for future use, type:

```
SAVE "SAMPLE" <ENTER>
```

2. To return to TRSDOS-II Ready, type:

```
SYSTEM <ENTER>
```

Now you can run the "Hello" program whenever you wish. To do so, use the diskette you are using now. Load the BASIC interpreter by typing BASIC <ENTER>. To load the SAMPLE program, type:

```
LOAD "SAMPLE" <ENTER>
```

Run the program by typing RUN <ENTER>.

## Disk Format and Disk Files

You can store programs and then easily retrieve and run them because of the efficient way TRSDOS-II organizes information on disks. The two parts of this organization are:

- . Disk Format
- . Disk Files

Formatting prepares disks for information storage. It divides disks into the parts of TRSDOS-II's "filing" system: cylinders, tracks, sectors, and bytes. It also creates a directory on each disk.

3. To see the directory that is on your TRSDOS-II diskette, return to TRSDOS-II Ready by typing SYSTEM <ENTER>. Then type:

```
DIR <ENTER>
```

TRSDOS-II lists all the user files stored on the diskette.

You can store information on formatted disks only. Any disk that contains an application program or operating system -- such as your TRSDOS-II diskette -- already is formatted. The blank diskettes you buy in a Radio Shack Computer Center are not formatted, so you cannot yet store information on them. You'll learn how to format them in Chapter 4, "Floppy Diskette System Preparation."

Disk files are similar to the files in a file cabinet. They can contain whatever you put in them -- programs, data, information -- and each file has a different name.

Disk files usually are created through an application program. Using BASIC, you created a disk file called SAMPLE. Other disk files are created in similar ways.

### Removing and Swapping Diskettes

You have used one operating system, one application program, and one diskette. When you use the Computer daily, you will use more than one diskette and maybe more than one operating system or application program. To help prevent errors and accidental loss of information, follow these steps:

- . When you are finished using a diskette, exit the application program by returning to TRSDOS-II Ready. Make sure the drive light is off. Then remove the diskette.
- . When swapping diskettes in a drive, type I <ENTER> after inserting the new diskette. If you swap the diskettes in Drive 0, they must contain the same operating system. If they do not, press the reset button after the swap to start up the new operating system.
- . When you're finished using the Computer, remove all diskettes and turn off the Computer system.

## Chapter 4: FLOPPY DISKETTE SYSTEM PREPARATION

This chapter explains how to start your floppy diskette system. It explains how to use TRSDOS and TRSDOS-II application programs and how to make data diskettes. If you have a hard disk unit, go to Chapter 5, "Hard Disk System Preparation."

### Using TRSDOS-II Application Programs

TRSDOS-II application programs use TRSDOS-II as their operating system. If one or more of the following statements is true of your application program, it is a TRSDOS-II application program:

- . TRSDOS-II is written on the label of a program diskette
- . TRSDOS-II Ready appears after you insert a program diskette into Drive 0 and enter the date and time
- . The application program manual states that TRSDOS-II is on one of the application program diskettes

To use TRSDOS-II application programs, follow the directions in your application program manuals. If you want to use data diskettes with your TRSDOS-II application program, see "Formatting Diskettes" in this chapter.

### Using TRSDOS Application Programs

Many Radio Shack application programs use TRSDOS 2.0a instead of TRSDOS-II. You can use TRSDOS 2.0a programs on your Model 12. To do so, you must do one of the following:

- . Use a TRSDOS System Diskette (Version 2.0b) in Drive 0
- . "Patch" your programs (THINLINE) with the TRSDOS System Diskette
- . Convert your programs to the TRSDOS-II format

### Using the TRSDOS 2.0b System Diskette in Drive 0

The simplest way for Model 12 owners to use TRSDOS 2.0a programs is to keep a TRSDOS 2.0b System Diskette in Drive 0. To use this method, however, you must have enough drives for your application program diskettes.

Power up the Computer and place the TRSDOS System Diskette in Drive 0. Place the TRSDOS 2.0a application program diskettes in the other drives. Then run the program as instructed in your application program manual.

### Patching Programs with TRSDOS 2.0b

Another easy way to use a TRSDOS 2.0a program is to copy some information from your TRSDOS 2.0b System Diskette onto the TRSDOS 2.0a application diskette. This information allows the TRSDOS 2.0a program to run on the Model 12's Thinline drives. To patch your application program in this way, follow the steps below:

1. Power up the Computer.
2. Insert the TRSDOS 2.0b System Diskette into Drive 0.
- 3a. Multi-Drive Users:

Insert the TRSDOS 2.0a application diskette into Drive 1. Then enter the date and time.

When TRSDOS READY is displayed, type:

```
COPY THINLINE:0 :1 <ENTER>
```

This copies the THINLINE patch file to your TRSDOS 2.0a application diskette. When TRSDOS READY appears, remove the TRSDOS System Diskette from Drive 0. Without pressing <I>, <BREAK>, or the reset button, move your TRSDOS 2.0a application diskette from Drive 1 to Drive 0. Type:

```
DO THINLINE <ENTER>
```

When the message:

```
PAUSE Patch System for Thinline drives; Mount
Diskette in Drive 0
Press ANY key to continue
```

appears, press <ENTER>. TRSDOS READY is displayed when all the patches are complete. Press the reset button to load the patched operating system into memory. You can now use the patched diskette as instructed in your application program manual.

3b. Single-Drive Users:

Enter the date and time. At TRSDOS READY, type:

```
COPY THINLINE:0 :0 <ENTER>
```

The following prompts appear:

```
Mount SOURCE disk
Press ANY key to continue
```

Since your source diskette is already mounted, press <ENTER>. The screen then shows:

```
Mount DESTINATION disk
Press ANY key to continue
```

Remove the TRSDOS System Diskette from Drive 0. Insert the TRSDOS 2.0a application diskette. Press <ENTER>. When TRSDOS READY appears, make sure the TRSDOS 2.0a application diskette is in Drive 0 and type:

```
DO THINLINE <ENTER>
```

The following prompt appears:

```
PAUSE Patch System for Thinline drives; Mount
Diskette in Drive 0
Press ANY key to continue
```

When all the patches are complete, TRSDOS READY is displayed. Press RESET to load the patched operating system into memory. You can now use the patched diskette as instructed in your application program manual.

### Converting TRSDOS 2.0a Programs to TRSDOS-II

If you prefer, you can convert your TRSDOS 2.0a program to a TRSDOS-II program. A TRSDOS-II program can use double-sided diskettes and hard disk. It can store more data per diskette and retrieve and store information faster than a TRSDOS 2.0a program.

To convert your TRSDOS 2.0a program to a TRSDOS-II program, refer to the insert supplied with the TRSDOS-II Reference Manual.



### Formatting Diskettes

Your Computer stores information on formatted disks. Operating system and application program diskettes are formatted, but they may not have enough space left for other information.

If you have a multi-drive Computer, you may wish to store information on "data diskettes." A data diskette is formatted but does not contain an operating system. It has more storage space than an operating system or application program diskette.

**Caution:** While a disk is being formatted, any previous information on the disk is **erased**.

To make a data diskette, follow these steps.

1. Power up the Computer.
2. Place a write-enable tab over the write-protect notch of the diskette to be formatted (destination diskette).
- 3a. To make a data diskette to use with a TRSDOS-II application program, insert a TRSDOS-II system diskette into Drive 0.
- 3b. To make a data diskette to use with a TRSDOS application program, insert a TRSDOS system diskette into Drive 0.
4. Enter the date and time.
5. When TRSDOS-II Ready or TRSDOS READY appears, insert the destination diskette into Drive 1. Type:

```
FORMAT 1 <ENTER>
```

6. If you are formatting over a used diskette, a prompt appears asking if you want to format over it.

If you do not need the data on the diskette, type Y <ENTER>. If you might need the data, type Q <ENTER>.

TRSDOS-II Ready or TRSDOS READY is displayed when the diskette is formatted.

To use TRSDOS-II data diskettes, place a TRSDOS-II system diskette in Drive 0. Insert the data diskettes in the other floppy drives. Then use your application program as instructed in the application program manual.

To use TRSDOS or TRSDOS 2.0a data diskettes, place a patched TRSDOS (2.0b) system diskette in Drive 0. Insert the data diskettes in the other floppy drives. Then use the application program as instructed in the application program manual.

## Chapter 5: HARD DISK SYSTEM PREPARATION

Your Hard Disk Owner's Manual explains in detail how to get your hard disk system started. The following steps summarize the information contained in that manual.

1. **Prepare your primary hard disk (Drive 4).** Do this by transferring TRSDOS-II and BASIC Interpreter from the diskette supplied with your hard disk to Drive 4. Do this even if a service technician did it for you.

If you have stored information on a hard disk, use the SAVE or MOVE command (see Appendix A, "Making Backup Copies of Files and Disks") to make copies of the files before transferring TRSDOS-II and BASIC.

2. **Prepare your secondary hard disks (Drives 5-7).** If you have more than one hard disk unit, prepare Drives 5-7 as instructed in your Hard Disk Owner's Manual.

3. **Prepare your TRSDOS 2.0a application programs.** Many Radio Shack application programs use TRSDOS 2.0a instead of TRSDOS-II. You can use TRSDOS 2.0a programs in two ways:

- Operate under floppy diskette control (see "Using TRSDOS Application Programs" in Chapter 4).
- Use the FCOPY command to convert them to TRSDOS-II format and copy them to your hard disk. Instructions are in the insert supplied with the TRSDOS-II Reference Manual.

4. **Copy TRSDOS-II programs onto a hard disk.** TRSDOS-II application programs use TRSDOS-II as their operating system. If you have a TRSDOS-II program, you can use it in two ways:

- Operate under floppy diskette control (see "Using TRSDOS-II Application Programs" in Chapter 4).
- Use the MOVE command to copy the program from floppy diskette to hard disk.

5. Create a backup library. Through operator error, power failure, or other accidents, you can lose information stored on hard disk. To prevent the loss of a day's, week's, or even month's work, keep up-to-date copies of all the files that are on your hard disk. Instructions are in Appendix A of this manual (see "Making SAVE/RESTORE Compressed Copies") and in your Hard Disk Owner's Manual.

## Chapter 6: MAINTENANCE

## Taking Care of your Diskettes

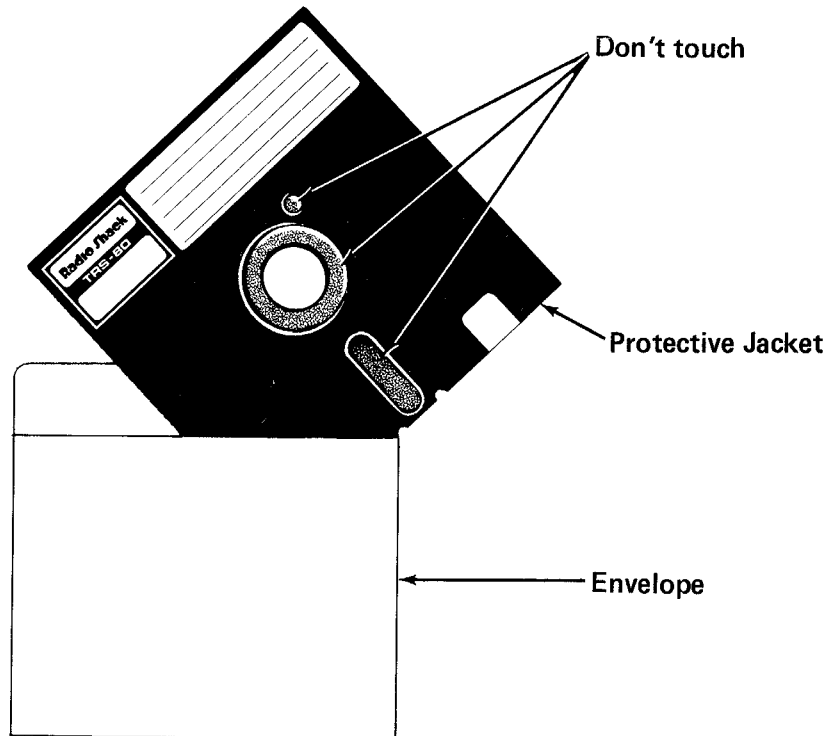

Diskettes are sensitive. A small dent, scratch or a speck of dust can destroy a diskette's contents. Treat your diskettes with care.

- Never turn the computer on or off while a diskette is in a drive.
- Store diskettes in their envelopes, making sure there is no pressure to their sides.
- Keep diskettes away from magnetic fields (such as transformers, AC motors, magnets, TVs, and a computer's display console).

- . Don't bend diskettes.
- . Never touch a diskette's exposed, shiny surfaces. Do not try to wipe or clean diskette surfaces; they scratch easily.
- . Keep diskettes out of direct sunlight and away from heat.
- . Keep diskettes away from cigarette ashes, dust, and other particles. In dusty areas, provide filtered air to the computer room.
- . Don't write on the diskette jacket with a hard point device such as a ball point pen or lead pencil. Use a felt-tip pen only.

### Drive Maintenance

Your Model 12's floppy diskette drives need periodic care. Most of this is cleaning which prevents damage to diskettes. Have a Radio Shack service technician check your floppy diskette drives every six months or less. Ask a sales representative at a Radio Shack Computer Center about diskette drive head cleaning kits.

Hard disk drives need special care, too. For details, refer to your Hard Disk Owner's Manual.

APPENDICES

## APPENDIX A: BACKUP DISKS AND FILES

This appendix contains introductory information about using the following operating system commands:

- . BACKUP
- . COPY
- . MOVE
- . SAVE/RESTORE

For complete information on the TRSDOS-II commands, refer to the TRSDOS-II Reference Manual.

### TRSDOS-II BACKUP

The TRSDOS-II BACKUP command makes a copy of a diskette. If you have two or more floppy diskette drives, use BACKUP to copy:

- . The TRSDOS-II System Diskette
- . Other TRSDOS-II system diskettes, including TRSDOS-II application program diskettes
- . TRSDOS-II data diskettes

Remember that you cannot backup double-sided to single-sided diskettes.

### Backing Up TRSDOS-II System Diskettes

If you have two or more floppy diskette drives, you can back up the TRSDOS-II System Diskette or any other diskette that contains the TRSDOS-II system by following these steps:

1. Power up your Computer. Insert the TRSDOS-II system diskette you wish to copy (source diskette) into Drive 0.
2. Enter the date and time.



3. When TRSDOS-II Ready appears, insert the destination diskette into Drive 1 (use a double-sided destination diskette for maximum storage space), type:

```
BACKUP Ø TO 1 <ENTER>
```

4. The message:

```
Backup Successfully Completed  
Drive 1 Disk ID is: TRSDOS  
TRSDOS-II Ready
```

is displayed when the backup is finished.

#### Backing Up TRSDOS-II Data Diskettes Using a Floppy Diskette System

Follow these steps to make a backup of a TRSDOS-II data diskette:

1. Power up your Computer. Insert a TRSDOS-II System Diskette into Drive Ø and the source data diskette into Drive 1.
2. Enter the date and time.
3. If you have three or four floppy drives, insert the destination diskette into Drive 2. Use a double-sided destination diskette for maximum storage space.

- 4a. Users with Three Floppy Drives:

```
Type: BACKUP 1 TO 2 <ENTER>
```

"Backup Successfully Completed" appears when the BACKUP is finished.

- 4b. Users with Two Floppy Drives:

```
Type: BACKUP 1 TO Ø <ENTER>
```

The message

Replace system diskette with destination diskette.  
Ready? (Y)..

appears. Remove your TRSDOS-II system diskette from Drive 0 and insert the destination diskette. Type Y <ENTER> and the backup will continue.

When the backup is complete, the message

Mount system disk. Ready? (Y)..

is displayed. Remove the destination diskette from Drive 0 and insert your TRSDOS-II system diskette. Press Y <ENTER> and TRSDOS-II Ready appears.

#### Backing Up TRSDOS-II Data Diskettes Using a Hard Disk System

You need two floppy diskette drives for this method.

1. Power up under hard disk control.
2. Insert the TRSDOS-II data diskette into Drive 0.  
Insert the destination diskette into Drive 1. Use a double-sided diskette for maximum diskette storage space.
3. Enter the date and time.
4. When TRSDOS-II Ready appears, type:

BACKUP 0 TO 1 <ENTER>

"Backup Successfully Completed" appears when the backup is finished.

## TRSDOS BACKUP

The TRSDOS BACKUP command copies a TRSDOS diskette. It is slightly different from the TRSDOS-II BACKUP command. You can use it to copy:

- . The TRSDOS System Diskette
- . Other TRSDOS 2.0b system diskettes
- . TRSDOS data diskettes

### Backing Up TRSDOS System Diskettes

To backup the TRSDOS System Diskette or any other diskette that contains the TRSDOS system (Version 2.0b), use the following steps:

1. Power up or reset the Computer. If you have a hard disk, operate under floppy diskette control.
2. Insert the TRSDOS diskette you wish to copy (source diskette) into Drive 0.
3. Enter the date and time. TRSDOS READY appears.
- 4a. Multi-Drive Users:

Insert the single-sided destination diskette into Drive 1. Type:

```
FORMAT 1 <ENTER>
```

When TRSDOS READY reappears, type:

```
BACKUP 0 TO 1 <ENTER>
```

TRSDOS READY appears when the backup is finished.

- 4b. Single-Drive Users:

Type:

```
FORMAT 0 <ENTER>
```

Place the destination diskette in Drive 0 when prompted.

When TRSDOS READY reappears, make sure the TRSDOS diskette is in Drive 0. Type:

```
BACKUP 0 TO 0 <ENTER>
```

Swap the source and destination diskettes when prompted. TRSDOS READY appears when the backup is finished.

### Backing Up TRSDOS Data Diskettes

Use this method to back up TRSDOS 2.0a and 2.0b data diskettes. (You can also use this method to back up TRSDOS 2.0b system diskettes.) You need two or more floppy diskette drives.

1. Turn on or reset the Computer with a TRSDOS 2.0b diskette in Drive 0. If you have a hard disk, operate under floppy diskette control.
2. Enter the date and time.
- 3a. Two-Drive Users:

When TRSDOS READY appears, insert the single-sided destination diskette into Drive 1. Type:

```
FORMAT 1 <ENTER>
```

When TRSDOS READY appears again, remove the destination diskette from Drive 1. Insert the diskette you wish to copy. Type, at TRSDOS READY:

```
I <ENTER>  
BACKUP 1 TO 0 <ENTER>
```

When the message "Destination Diskette Ready? (Y/Q)" appears, remove your TRSDOS system diskette from Drive 0 and insert the formatted destination diskette.

When the backup is finished and TRSDOS READY is displayed, you are prompted to insert a system diskette into Drive 0.

3b. Three- or Four-Drive Users:

When TRSDOS READY appears, insert the diskette you wish to copy into Drive 1. Insert a single-sided destination diskette into Drive 2.

When TRSDOS READY appears, type:

```
FORMAT 2 <ENTER>
```

When TRSDOS READY appears again, type:

```
BACKUP 1 TO 2 <ENTER>
```

TRSDOS READY appears when the backup is finished.

### Making SAVE/RESTORE Compressed Copies

The SAVE utility stores files in a special, compact form on floppy diskettes. Because of the special format, files occupy less space they normally would on floppy diskettes. TRSDOS-II cannot directly read files stored in this format.

The RESTORE utility returns saved information to a TRSDOS-II formatted disk. It is the only way to retrieve to information stored by SAVE.

SAVE is a good way to make archive copies of hard disk files. To decide how often to make save copies of your hard disk files, think how much time, effort, and money could be lost if your hard disk files suddenly were destroyed. We suggest hard disk users keep two major sets of archive files:

- . Monthly Save Set -- A set of save diskettes containing everything on your hard disks, including your programs. Make this set on the first day of each month. Always keep a previous month's save set and a current month's save set.
- . Daily Save Set -- A set of save diskettes containing the files that were created or changed since the current monthly save set was made. Make this set at the end of each day. Always keep a previous daily save set and a current daily save set.

If you enter large amounts of data every day, you might want to make more than one "daily" save set each day. No matter how much data you enter, however, never wait longer than three days before making a daily save set.

**Note:** The examples in this section use Drive 4 (hard disk) as the source and Drive 0 as the destination. This is because SAVE and RESTORE are intended for hard disk use. However, SAVE and RESTORE can also be used to save files from a TRSDOS-II formatted floppy diskette to a SAVE formatted diskette.

When using SAVE and RESTORE between two floppy diskette, be sure:

- . the source and destination drive numbers are different
- . the destination drive number is not Drive 0, since Drive 0 must contain a TRSDOS-II system diskette

### Creating a Monthly Save Set

Creating a monthly save set takes time, but it's worth it. Have several blank, unformatted diskettes ready.

To save all the files (including system files) and programs from hard disk Drive 4 to a floppy diskette in Drive 0, insert a floppy diskette into Drive 0. At TRSDOS-II Ready, type:

```
SAVE :4 :0 {SYS,ALL,ABS} <ENTER>
```

TRSDOS-II displays a "volume number" which identifies the diskette in Drive 0. A "dataset signature" identifies the set of diskettes. Write down the volume number and dataset signature. When you later remove the diskette from the drive, write this information on the diskette's label.

When the diskette is full, TRSDOS-II prompts you to insert another diskette. When all the files are saved, TRSDOS-II prompts you to reinsert the first diskette of the set (Volume 0). It then updates the diskette with housekeeping information.

TRSDOS-II Ready appears when the SAVE is finished. Make sure you have labeled all the save diskettes. Store them in a safe place.

At the beginning of the next month, create a new monthly save set using a different set of diskettes. This set becomes the "current monthly save set." The other set becomes the "previous monthly save set."

### Rotating Monthly Save Sets

When you have two monthly save sets, begin rotating the diskettes. When you make a new monthly save set, use the older monthly save set diskettes instead of blank diskettes.

### Creating a Daily Save Set

To create a daily save set of all the Drive 4 files that were created or changed since the monthly save set was created, type:

```
SAVE !:4 :Ø {DM>mmddy,ABS,SYS} <ENTER>
```

Instead of typing "mmddy," type the date that you made the most recent monthly save set.

At the end of the next day, create a new daily save set, using different diskettes. This set becomes the "current daily save set." The other set is the "older daily save set."

### Rotating Daily Save Sets

Once you have two daily save sets, rotate the diskettes. When you make a new daily save set, use the older daily save set diskettes instead of blank diskettes.

### Restoring your Files

To restore information to a hard disk other than Drive 4, replace "4" with the desired drive number in each of the following commands.

#### Restoring One File

If you want to restore only one file, insert Volume Ø of your most recent save set into Drive Ø and type:

```
RESTORE filespec:Ø :4 {ABS} <ENTER>
```

where filespec is the name of the file you want to restore.



### Restoring a Group of Files

To restore a group of files, insert Volume Ø of your most recent save set into Drive Ø. Type:

```
RESTORE :Ø :4 {PROMPT} <ENTER>
```

TRSDOS-II prompts you before restoring each file. Press <Y> to restore a file. Press <N> if you don't wish to restore the file.

### Restoring All Files

If you lose most or all of the data on your hard disk(s), follow these steps to recover the lost data:

1. If Drive 4's operating system is damaged, re-transfer TRSDOS-II and BASIC from the diskette supplied with your hard disk to Drive 4. Instructions are in your Hard Disk Owner's Manual.

If you are sure Drive 4's operating system is not damaged, go to Step 2.

2. Insert Volume Ø of your current monthly save set into Drive Ø. At TRSDOS-II Ready, type:

```
RESTORE :Ø :4 {ABS,SYS} <ENTER>
```

Follow TRSDOS-II's prompts.

3. Insert Volume Ø of your current daily save set into Drive Ø. At TRSDOS-II Ready, type:

```
RESTORE :Ø :4 {ABS,SYS} <ENTER>
```

4. Re-enter any information added to the hard disk since the last current daily save set was created.

### MOVE

The MOVE command copies files. For example, to copy all user files from the diskette in Drive 1 to the diskette in Drive 2, type:

```
MOVE 1 TO 2 {ALL} <ENTER>
```

The MOVE command is especially useful if you have two or more hard disks. You can copy all the files from one hard disk drive onto a second hard disk drive and then turn the second drive off-line. This procedure quickly copies your files and then protects the copies by making them temporarily inaccessible. You can access the copies by turning the drive back on-line.

To create a command file that copies files from Drive 4 onto Drive 5 and then turns Drive 5 off-line, follow these steps:

1. At TRSDOS-II Ready, type:

```
BUILD DISKMOVE:4 <ENTER>
```

2. When the message

```
Enter command line (1-80)
```

is displayed, type:

```
MOVE 4 TO 5 {ALL} <ENTER>
```

3. The line you typed is highlighted and the following question appears:

```
Store Line? (cr/esc)
```

If the highlighted line is correct, press <ENTER>. If the line is incorrect, press <ESC> and type the line again. Do this whenever the Store Line? prompt appears.

4. Type:

```
DRIVE 5 {OFFLINE} <ENTER>
```

5. To end to command file, press <ENTER> instead of typing a new command line. TRSDOS-II Ready reappears.

After following Steps 1 - 5, you can copy all the user files from Drive 4 to Drive 5 and then turn Drive 5 off-line by typing:

```
DO DISKMOVE:4 <ENTER>
```

### COPY

To copy one file at a time, use the COPY command. For example, to copy a file named SAMPLE from a diskette in Drive 1 to a diskette in Drive 2, type:

```
COPY SAMPLE:1 TO 2 <ENTER>
```

## APPENDIX B: MORE ABOUT TRSDOS-II

For an introduction to four often-used TRSDOS-II commands -- DRIVE, HELP, KILL, and PURGE -- read this appendix.

For an introduction to:

- . BACKUP, COPY, MOVE, SAVE, and RESTORE, refer to Appendix A, "Making Backups."
- . DIR, refer to Chapter 3, "Sample Session."
- . FORMAT, refer to Chapter 3, "Sample Session," and Chapter 4, "Floppy Diskette System Preparation."

For detailed information about all the TRSDOS-II commands, see the TRSDOS-II Reference Manual.

### Increasing Drive Efficiency -- Using the DRIVE Command

When TRSDOS-II starts up it establishes the settings that determine how your drives work. However, these automatic drive settings might not be the best way to run your Computer's drives. The DRIVE command lets you specify the best settings for your Computer.

For the best results, enter a separate DRIVE command for the four floppy diskette drives, even if your Computer doesn't have them all.

In addition, if you have a hard disk system, enter a separate command for each hard disk drive you don't have.

By creating a comand file that automatically executes the DRIVE commands, you can avoid typing the commands each time TRSDOS-II is loaded. The following steps explain how.

- 1a. Floppy Diskette System Users:  
Place a TRSDOS-II System Diskette in Drive Ø.
- 1b. Hard Disk System Users:  
Power up under hard disk control.

2. At TRSDOS-II Ready, type:

```
BUILD DRIVESSET <ENTER>
```

3. When:

```
Enter command line (1-80)
```

is displayed, type:

```
DRIVE 0 {RATE=0,DETECT,WAIT} <ENTER>
```

4. The line you typed is highlighted and the question:

```
Store Line? (cr/esc)
```

appears. If the highlighted line is correct, press <ENTER>. If the line is incorrect, press <ESC> and type the line again. Do this whenever the Store Line? prompt appears.

5. If you have Drive 1, type:

```
DRIVE 1 {RATE=0,DETECT,WAIT} <ENTER>
```

If you do not have Drive 1, type:

```
DRIVE 1 {OFFLINE} <ENTER>
```

Do the same for Drives 2 and 3, substituting the appropriate drive number.

- 6a. Floppy Diskette System Users and Users with Four Hard Drives:

Press <ENTER> instead of typing a new command line to end the DO file. You are now ready to execute the file. To do so, type at TRSDOS-II Ready:

```
AUTO DO DRIVESSET <ENTER>
```

6b. Hard Disk System Users with Less Than Four Hard Drives:

If you do not have Drive 5, type:

```
DRIVE 5 {OFFLINE} <ENTER>
```

Do the same for each hard drive not present in your system, substituting the appropriate drive number.

Press <ENTER> instead of typing a new command line to end the DO file. You are now ready to execute the file. To do so, type at TRSDOS-II Ready:

```
AUTO DO DRIVESET <ENTER>
```

Now, whenever you use this disk to start up your Computer, the drives run as set by the commands. When you add drives, you can use the KILL command to delete the DRIVESET program and create a new command file or use the BUILD edit function to edit the file. (BUILD is described in your TRSDOS-II Reference Manual.)

### HELP

The HELP command displays information about TRSDOS-II. For example, to display a list of subjects for which help is available, type, at TRSDOS-II Ready:

```
HELP <ENTER>
```

The display is similar to the following:

```
APPEND  copies contents of a file to the end of another file
ATTRIB  assigns or changes the password and protection level of a file
AUTO    stores a command for automatic execution after system startup
.       .
.       .
.       .
FLOPPY  ignores all references to floppy drive numbers in files
```

Press any Key to continue

Pressing <ENTER> displays the next screen of information.

To display the "syntax" (command format) for one of the subjects listed, enter the HELP command with that subject. For example, at TRSDOS-II Ready, type:

```
HELP DIR <ENTER>
```

and TRSDOS-II displays:

```
DIR [fs | wc] [:d] {[SYS] [PRT]}
```

To interpret a syntax display, type:

```
HELP SYNTAX
```

The Computer displays the syntax symbols and their meanings.

### KILL

Use the KILL command to delete one or more files. For example, at TRSDOS-II Ready, type:

```
KILL SAMPLE:Ø <ENTER>
```

and TRSDOS-II deletes a file named SAMPLE from a diskette in Drive Ø.

### APPENDIX C: MAKING A MINIMUM SYSTEM DISKETTE

Using TRSDOS-II and double-sided diskettes gives you more space than using TRSDOS and single-sided diskettes. If, however, you need even more space, you can make a "minimum system" diskette.

This is a diskette that contains only the part of the operating system that your program needs. To make a minimum system diskette, follow these steps:

1. Insert a backup TRSDOS-II diskette into Drive Ø.
2. At TRSDOS-II Ready, type:
 

```
PURGE Ø {SYS} <ENTER>
```
3. Enter the diskette's password when prompted. The password for the TRSDOS-II diskette is PASSWORD.
4. When prompted, press <Y> to delete a file or <N> to keep a file. Never delete a file unless you are sure you do not need it. The following chart contains guidelines to help you decide which files to delete.

File	Brief Description
SYSRES/SYS	Contains the operating system information needed to start TRSDOS-II. (keep this file)
SYSTEM/SYS	Contains the operating system information that is needed on all diskettes used in Drive Ø. (keep this file)
BASIC	Contains the BASIC Interpreter program. You may delete this file, if you do not plan to use a BASIC program.
APPEND	Copies a file onto the end of another file. (You may delete this file.)
BACKUP	Makes a mirror-image copy of a diskette. (keep this file)



File	Brief Description
BUILD	Creates a command input file which is executed with the DO command. (You may delete this file.)
COPY	Copies a file. (You may delete this file.)
CREATE	Creates a file and pre-allocates space for it. (You may delete this file.)
DRIVE	Changes floppy diskette drive settings and turns floppy or hard disk drives offline or online. (keep this file)
DUMP	Copies a machine-language program from memory to disk. (You may delete this file.)
FCOPY	Copies a TRSDOS file to a TRSDOS-II disk. (You should keep this file.)
FILES	Displays or prints an alphabetical list of the filenames on a disk. (You may delete this file.)
FORMAT	Prepares a blank disk for use. (keep this file)
HELP	Displays information about commands and certain subjects. (You may delete this file.)
LIST	Lists the contents of a file, including the record numbers and hexadecimal codes. (You may delete this file.)
MEMTEST	Tests the Computer's random access memory (RAM). (You may delete this file.)
MOVE	Copies files and reduces fragmentation of the files. (You may delete this file.)
PATCH	Makes minor corrections to disk files. (You should keep this file.)

File	Brief Description
PRINT	Prints the contents of a file, omitting the record numbers and hexadecimal codes. (You may delete this file.)
RECEIVE	Lets you receive object code into RAM from another device. (You may delete this file.)
RESTORE	Recovers files stored on floppy diskettes by the SAVE command. (You may delete this file.)
SAVE	Copies files onto floppy diskettes in a special, compressed format. (You may delete this file.)
TERMINAL	Transforms a Computer into a terminal. (You may delete this file.)

## APPENDIX D: GLOSSARY

- Application program** -- A computer program that lets you perform various applications such as word processing, graphics, and bookkeeping.
- Application data diskette** -- A data diskette that is used only with a particular application program.
- Application program diskette** -- A diskette that contains an operating system and all or part of an application program.
- Backup diskette** -- A mirror-image copy of a diskette.
- BASIC** -- Beginners' All-purpose Symbolic Instruction Code. A programming language.
- Boot up** -- To turn on a computer system (including all peripherals) and load an operating system or program.
- Command** -- A function the computer performs upon your instructions.
- Cursor** -- The flashing, white box (on the display) where you enter data or instructions.
- Data disk** -- A diskette that can store information, but does not contain an operating system. A formatted disk.
- Disk** -- A storage device. A floppy diskette or a hard disk.
- Diskette** -- A storage device. See the illustration at "Floppy Diskette."
- Double-sided diskette** -- A floppy diskette that lets you store information on both sides.
- Floppy diskette** -- A removable storage device.

- Floppy diskette control** -- Under the control of an operating system on a diskette in Drive 0.
- Floppy diskette drive** -- A device that stores information on a removable magnetic medium (floppy diskette).
- Floppy diskette expansion unit** -- External (not in the display console) floppy drives.
- Floppy diskette operation** -- Computer operation controlled by an operating system on a diskette in Drive 0.
- Floppy drive** -- See "Floppy diskette drive."
- Formatted disk** -- A disk that has been formatted with the FORMAT command. A disk that can store information.
- Hard disk** -- See "Hard disk unit."
- Hard disk control** -- Under the control of an operating system in Drive 4.
- Hard disk drive** -- See "Hard disk unit."
- Hard disk unit** -- A storage device with non-removable media.
- Hard disk operation** -- Operation under the control of an operating system in Drive 4.
- Master diskette** -- The original diskette you received when you purchased the product.
- Off-line** -- Status of equipment in which the computer considers it unusable.
- On-line** -- Status of equipment in which the computer consider it usable.
- Operating system** -- A program that enables you to use the computer and peripheral equipment.
- Operating system disk** -- A disk that contains an operating system.
- Power up** -- To turn on the computer system (including all peripheral equipment).

- Program** -- Instructions that tell a computer how to do something.
- Program disk** -- A disk that contains a program.
- Software** -- Operating systems and application programs.
- System files** -- The programs that make up the system operating routine. These can include certain language and application programs. To see a list of system files, type DIR {SYS} at TRSDOS-II Ready.
- Thinline drives** -- The internal drives of the Model 12 Computer, so named because they are only half as wide as the standard 8-inch disk drives.
- TRSDOS 2.0b** -- A version of the TRSDOS 2.0a operating system that can run on Thinline drives. Called "TRSDOS" in this manual.
- TRSDOS system diskette** -- Any diskette that contains TRSDOS 2.0b. It can contain other information, also.
- TRSDOS System Diskette and Basic Interpreter** -- The system diskette that came with your Model 12; it contains TRSDOS 2.0b and BASIC. TRSDOS 2.0b allows you to use TRSDOS 2.0a programs on the Model 12's Thinline drives.
- TRSDOS-II** -- The Model 12's native operating system.
- TRSDOS-II system diskette** -- Any diskette that contains TRSDOS-II. Can be used in Drive 0.
- TRSDOS-II System Diskette and BASIC Interpreter** -- The system diskette that came with your Model 12; it contains TRSDOS-II and BASIC.
- User files** -- Non-system files, which include user-created files and most application programs.
- Working diskette** -- A backup of an original diskette, used on an everyday basis.

**Write-enable tab** -- A gummed tab placed over a diskette's write-protect notch to enable you to change the information stored on the diskette. See "floppy diskette" for an illustration of the write-protect notch.

**Write-enabled disk** -- A disk that can have its information changed.

**Write-protected disk** -- A disk that cannot have its information changed.

**APPENDIX E: PROBLEMS AND ERROR MESSAGES****Unreadable Disks, Files, and Programs**

If you suddenly cannot use your disk, files, or programs, static electricity might be the cause. Try humidifiers and anti-static carpets to get rid of static electricity.

There are other causes. The Model 12's built-in AC line filter shields the Computer from minor changes in AC power, but extreme changes can ruin programs and files. If you think this is the problem, try these remedies:

- . Fix defective switches on nearby machines
- . Install bypass/isolation devices on noisy machines in your area
- . Install a separate power line to your Computer

**Error Messages**

If a displayed error message looks like:

- . \*\* ERROR 24 \*\*, see the Operating System Errors table
- . BOOT ERROR DC, see the Boot Errors table
- . Neither of the above, see your application program manual. (It might also be a descriptive operating system error generated by the application program.)

When an error message is displayed:

- . Try the operation several times.
- . Look up boot errors and operating system errors in the following tables and take the recommended actions.
- . Try using other diskettes.
- . Reset the Computer and try the operation again.
- . Check all the power connections.
- . Check all interconnections.
- . Remove all diskettes from drives, turn off the Computer, wait 15 seconds, and turn it on again.
- . If you try all these remedies and continue to get an error message, contact a Radio Shack Service Center.

**Note:** If there is more than one thing wrong, TRSDOS-II sometimes waits until you correct the first error before displaying another error message.

RSSC = Radio Shack Service Center.



## Operating System Errors Table

Code	Message	Explanation/Action
Ø	No Error Found.	No error occurred.
1	Bad Function Code On SVC Call Or No Function Exists.	Check the function code number used on the SVC call.
2	Character Not Available.	No record or character was available when you you called the SVC.
3	Parameter Error On Call.	Parameter is incorrect or a required parameter is missing.
4	CRC Error During Disk I/O.	Try the operation again, using a different diskette. If the problem occurs often, contact RSSC.
5	Disk Sector Not Found.	Try a different diskette.
6	Attempt To Open A File Which Has Not Been Closed.	Close the file before re-opening.
7	Illegal Disk Change.	TRSDOS-II detected an illegal disk swap.
8	Disk Drive Not Ready.	Drive door is open or the diskette is not in the drive. On Thinline drives, check the DRIVE command settings.
9	Invalid Data Provided By Caller.	Data stream to be processed has illegal characters.

Code	Message	Explanation/Action
10	Maximum Of 16 Files May Be Open At Once.	Too many files are open at once.
11	File Already In Directory.	Filename already exists as a directory entry. Kill the existing file, choose another filename, or specify a drive number.
12	No Drive Available For An Open.	No on-line drive a. is write enabled b. has enough space to create a new file, or c. has a system directory.
13	Write Attempt To A Read Only File.	File was opened for read only, not for read/write.
14	Write Fault On Disk I/O.	Error occurred during a write operation. Try a different diskette. If the problem continues, contact RSSC.
15	Disk Is Write Protected.	Write enable the disk.
16	DCB Is Modified And Is Unusable.	DCB (used in machine- language programming) has been modified since the last disk access (while the file was open).
17	Directory Read Error.	Error occurred during an attempt to read the directory. Use a different diskette.

Code	Message	Explanation/Action
18	Directory Write Error.	Error occurred during an attempt to write to the directory. Use a different diskette.
19	Improper File Name (Filespec).	Filespec you gave does not meet TRSDOS-II standard file specifications.
20	** Unknown Error Code **	
21	** Unknown Error Code **	
22	** Unknown Error Code **	
23	** Unknown Error Code **	
24	File Not Found.	Filename you gave was not found on the available disks or the file is the incorrect type for the desired operation.
25	File Access Denied Due To Password Protection.	You gave an incorrect password. See the ATTRIB command.
26	Directory Space Full.	Number of filenames has reached the amount set when you formatted the disk.
27	Disk Space Full.	No space is available on the disk.
28	Attempt To Read Past EOF.	Specified record number is past the EOF.
29	Read Attempt Outside Of File Limits.	Use valid record numbers.

Code	Message	Explanation/Action
30	No More Extents Available (16 Maximum).	Use the COPY command to copy the files and reduce fragmentation. See also SAVE/RESTORE and MOVE.
31	Program Not Found.	Specified program is not found on the available disks.
32	Unknown Drive Number (Filespec).	Specified drive number is not valid.
33	Disk Space Allocation Cannot Be Made Due To Fragmentation Of Space.	Use the COPY command to copy the files and reduce fragmentation.
34	Attempt To Use A NON Program File As A Program.	File specified for execution is not a program file or the load address given is illegal. Make sure you have a system diskette in Drive 0.
35	Memory Fault During Program Load.	Program is loaded incorrectly, possibly because of faulty memory or a "bad" load address.
36	Parameter For Open Is Incorrect.	Check the OPEN statements or the DCB for errors.
37	Open Attempt For A File Already Open.	File specified for open is already open.
38	I/O Attempt To An Unopen File.	Open the file before access.

Code	Message	Explanation/Action
39	Illegal I/O Attempt.	<ul style="list-style-type: none"> <li>a. I command not given after a diskette swap.</li> <li>b. Can be caused by an I/O attempt to a differently formatted disk. Format the disk under the current version of TRSDOS-II or use FCOPY.</li> <li>c. When initializing a hard disk, you must also format the secondary drives.</li> </ul>
40	Seek Error.	<ul style="list-style-type: none"> <li>a. Data cannot be read from the disk -- faulty disk.</li> </ul>
41	Data Lost During Disk I/O (Hardware Fault).	Contact RSSC.
42	Printer Not Ready.	Check the connections, power, ribbon, on-line status, and so on.
43	Printer Out Of Paper.	Check the printer's paper supply.
44	Printer Fault (May Be Turned Off).	Check the connections, power, ribbon, on-line status, and so on.
45	Printer Not Available.	Check the connections, power, ribbon, on-line status, and so on.
46	Not Applicable To VLR Type Files.	Operation performed is not valid for VLR files.
47	Required Command Parameter Not Found.	Required parameter or argument is missing from the command.

Code	Message	Explanation/Action
48	Incorrect Command Parameter.	Option or argument given in the command is incorrect.
49	Hardware Fault During Disk I/O.	Contact RSSC.
50	Invalid Space Descriptor.	The space descriptor that tells TRSDOS-II which extent to read next is invalid. Try a different diskette.
51-255	** Unknown error code **	

## Boot Errors Table

Error	Message	Explanation/Action
BOOT ERROR CK	Checksum error -- possibly a defective ROM.	Contact RSSC.
BOOT ERROR CT	Defective CTC chip.	Contact RSSC.
BOOT ERROR DC	Floppy disk controller error. a. Defective diskette. b. Floppy disk expansion unit. not on. c. System not powered properly. d. Defective FDC Chip or Drive.	a. Try a different diskette. b. Turn on the floppy disk expansion unit. c. Turn off your computer and power up properly. d. Contact RSSC.
BOOT ERROR DM	DMA chip failure.	Contact RSSC.
BOOT ERROR DØ	Drive not ready. a. Improperly inserted diskette. b. Defective diskette. c. Defective drive.	a. Insert the diskette again and press <RESET>. b. Try a different diskette. c. Contact RSSC.
BOOT ERROR HA	Controller error. Aborted command: Problem during boot-up of hard disk.	Re-initialize the hard disk or contact RSSC.
BOOT ERROR HC	CRC error. Invalid data in data field.	Re-initialize the hard disk or contact RSSC.

Error	Message	Explanation/Action
BOOT ERROR HD	Controller error. Busy not reset.	a. Re-initialize the hard disk. b. Power down, wait 10 seconds, and power up. If the error occurs again, contact RSSC.
BOOT ERROR HI	CRC error. Invalid data in ID field.	Re-initialize the hard disk.
BOOT ERROR HM	Data address mark not found.	Re-initialize the hard disk.
BOOT ERROR HN	ID not found. No Boot Track.	Re-initialize the hard disk.
BOOT ERROR HØ	Track Ø error on hard disk. a. Didn't find Track Ø before time-out. b. Secondary hard disk drives not turned on.	a. Press <RESET>. b. Turn on your secondary hard disk drives.
BOOT ERROR HT	Time-out while waiting for Ready. a. Hard disk drive not powered up. b. Hard disk drive isn't turned on and ready within 10 seconds after the computer. c. Hard disk drive is disconnected.	a. Follow correct procedure: Turn on the hard disk first. b. Press <RESET>. c. Connect the hard disk drive or operate under floppy disk control.



Error	Message	Explanation/Action
BOOT ERROR LD	Lost data during read -- FDC (floppy disk controller) or drive fault.	Try another TRSDOS-II diskette or contact RSSC.
BOOT ERROR MF	Memory failure in address range X'1000'-X'7FFF'.	Contact RSSC.
BOOT ERROR MH	Memory failure in address range X'8000'-X'FFFF'.	Contact RSSC.
BOOT ERROR ML	Memory failure in address range X'0000'-X'0FFF'.	Contact RSSC.
BOOT ERROR PI	Defective PIO Chip.	Turn on the expansion bay if it is off. If the error occurs again, contact RSSC.
BOOT ERROR RS	The diskette in Drive 0 is not Radio Shack operating system format.	Insert a TRSDOS-II formatted diskette into Drive 0 and press <RESET>.
BOOT ERROR SC	CRC Error. Invalid data on diskette or defective diskette.	Try a different diskette.
BOOT ERROR TK	Record not found bootstrap track. Improperly formatted or defective diskette.	Re-format your diskette or try a different diskette.

Error	Message	Explanation/Action
BOOT ERROR Z8	Defective CPU.	Contact RSSC.
NOT A SYSTEM DISK	Diskette in Drive Ø isn't a TRSDOS-II operating system diskette.	Insert a TRSDOS-II operating system diskette into Drive Ø.

## APPENDIX F: SPECIFICATIONS

The Radio Shack TRS-80 Model 12 is a disk-based Computer system with two major parts:

- A display console with one or two built-in, double-sided, double-density floppy disk drives
- A detached keyboard which can be positioned for your comfort and efficiency

The operating system software is loaded from an operating system disk in Drive 0 or Drive 4 by a built-in read-only memory (ROM) "bootstrap" program.

## Console

## Processor

- Z80-based microprocessor with 80K of memory: 64K bytes of user random access memory (RAM) and a 16K memory bank used by the operating system.
- The processor receives power-up and reset instructions from ROM. After the operating system initialization program is loaded from disk, ROM is electronically switched out of the system and replaced with RAM.
- Compatibility with existing Model II software.

## Sound

Capable of generating two types of sound :

- Audible Alarm (see the SOUND SVC in the TRSDOS-II Reference Manual)
- Keyboard Click (see the CLICK command in the TRSDOS-II Reference Manual)

## Video Display

### LSI Controller Chip

Frees the processor from much of the overhead required to update and maintain the video display.

### Four Modes

- . Green on black (normal display)
- . Black on green (reversed display)
- . 80 characters by 24 lines
- . 40 characters by 24 lines

### Displayable Characters

- . Full ASCII set
- . 32 graphics characters

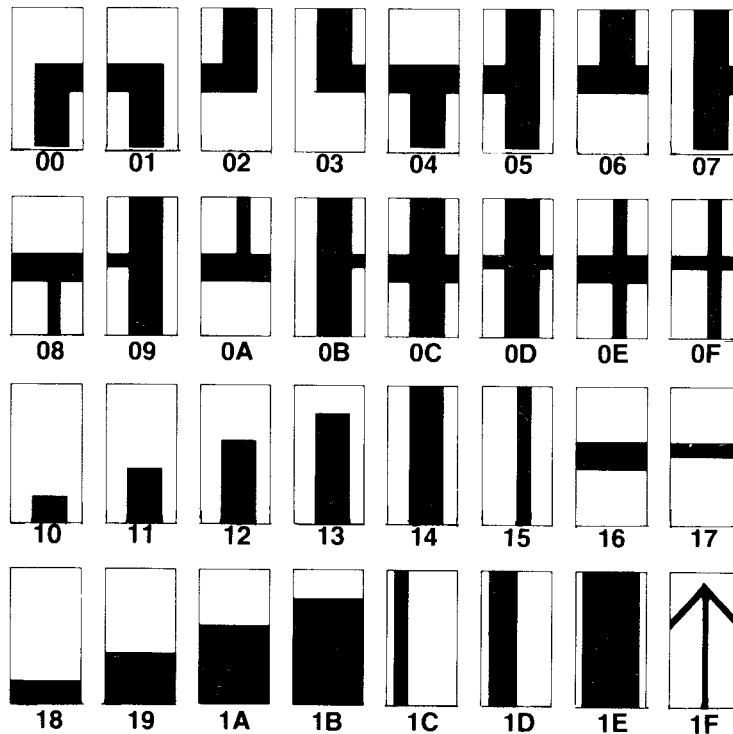

### Keyboard

- LSI Controller frees the processor from keyboard scan and related tasks
- Located in separate case for convenience
- Connected to display console via a built-in coiled cord exiting at the lower, back part of the keyboard
- Standard typewriter keys, repeat key, and eight general-purpose function keys
- Four modes with the following priority (highest to lowest):
  1. Control
  2. Shift
  3. Caps
  4. Unshift

### Floppy Diskette Drives

#### Minimum

One built-in, 8-inch, double-sided floppy diskette drive and one to four hard disks

or

Two built-in, 8-inch, double-sided floppy diskette drives

#### Preventive Maintenance Interval

- Typical usage (3,000 power-on hours per year): Every 8,000 power-on hours
- Heavy usage (8,000 power-on hours per year): Every 5,000 power-on hours

### Required Media

Radio Shack double- or single-sided, 8-inch floppy diskettes

Data Transfer Rate is 500,000 bits per second (except Track 0 which has 250,000 bps)

Diskette Life is 3.5 million passes per track. To prevent limiting life by improper handling, follow diskette-care recommendations.

### Power Supply

#### Power Requirements

- . 105-130 VAC, 60 Hz
- . 240 VAC, 50 Hz (Australian)
- . 220 VAC, 50 Hz (European)
- . Grounded outlet

#### Maximum Current Drain

2.0 Amps @ 120 VAC, 60 Hz

#### Typical Current Drain

1.5 Amps @ 120 VAC, 60 Hz

### Ambient Operating Temperature

- . 55 to 95 degrees Fahrenheit
- . 0 to 43 degrees Celsius

## Peripheral Interfaces

### Standard

- . Serial port A (RS-232C)
- . Serial port B (RS-232C)
- . Parallel input/output channel, for connection to TRS-80 standard parallel interface line printers
- . Floppy diskette input/output channel for connection of a floppy diskette expansion unit

### Optional

Card Cage which gives an additional six slots to accommodate:

- . Hard Disk Drive Interface
- . Graphics Board
- . 16-Bit Enhancement
- . Memory Board
- . and more!

**Serial Interface**

Two Ports:

- Channel A allows asynchronous or synchronous communication
- Channel B allows asynchronous communication only
- Both conform to the RS-232C standard
- Both use the DB-25 connectors on the back of the display console

The DB-25 connector pin-outs and signals available are listed below.

Channel A		Channel B	
Standard RS-232C Signal	Pin #	Standard RS-232C Signal	Pin #
I/O Transmit S.E.T.	15	Ground	1,7
Ground	1,7	Receive Data	3
Receive Data	3	Receiver Xmitter Clock	17
Receiver Clock	17	Data Set Ready	6
Transmit Clock	24	Clear-to-Send	5
Data Set Ready	6	Carrier Detect	8
Clear-to-Send	5	Transmit Data	2
Carrier Detect	8	Request-to-Send	4
Transmit Data	2	Data Terminal Ready	20
Request-to-Send	4		
Data Terminal Ready	20		

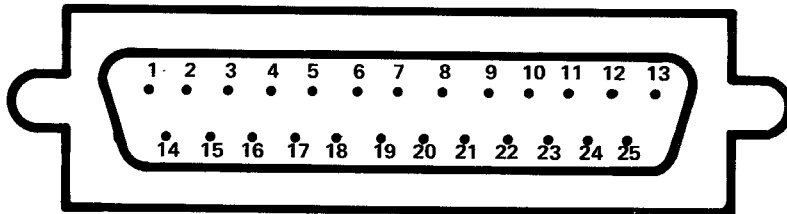



### Parallel Interface

- . Connection to a line printer via the 34-pin connector on the back panel of the display console
- . Eight data bits are output in parallel
- . Four data bits are input
- . All levels are TTL compatible

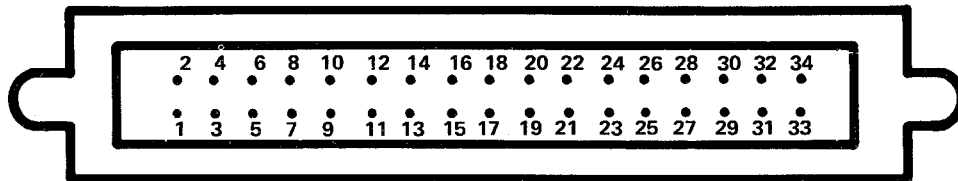

Signal	Function	Pin #
STROBE	1 microsecond pulse to clock the data from the processor to the printer	1
DATA 0	Bit 0 (lsb) of the output data byte	3
DATA 1	Bit 1 of the output data byte	5
DATA 2	Bit 2 of the output data byte	7
DATA 3	Bit 3 of the output data byte	9
DATA 4	Bit 4 of the output data byte	11
DATA 5	Bit 5 of the output data byte	13
DATA 6	Bit 6 of the output data byte	15
DATA 7	Bit 7 (msb) of the output data byte	17

Signal	Function	Pin #
ACK*	Input to the Computer from the printer; low indicates data byte is received	19
BUSY	Input to the Computer from the printer; high indicates busy	21
PAPER EMPTY	Input to the Computer from the printer; high indicates no paper -- if the printer doesn't provide this, the signal is forced low	23
SELECT	Input to the Computer from the printer; high indicates device is selected	25
PRIME*	Output to the printer to clear the buffer; reset the printer logic	26
FAULT*	Input to the Computer from the printer; low indicates fault (paper empty, light detect, deselect, and so on)	28
GROUND	Common signal ground	2, 4, 6, 8, 10, 12, 14, 16, 18, 20, 22, 24, 27, 31, 33
NC	Not connected	29, 30, 32, 34

\*These signals are active-low.

Model 12/Model 12 Communications

For hard-wiring between two Model 12s without a modem, use the wiring arrangement illustrated below (Model 12 to Model 12 only).

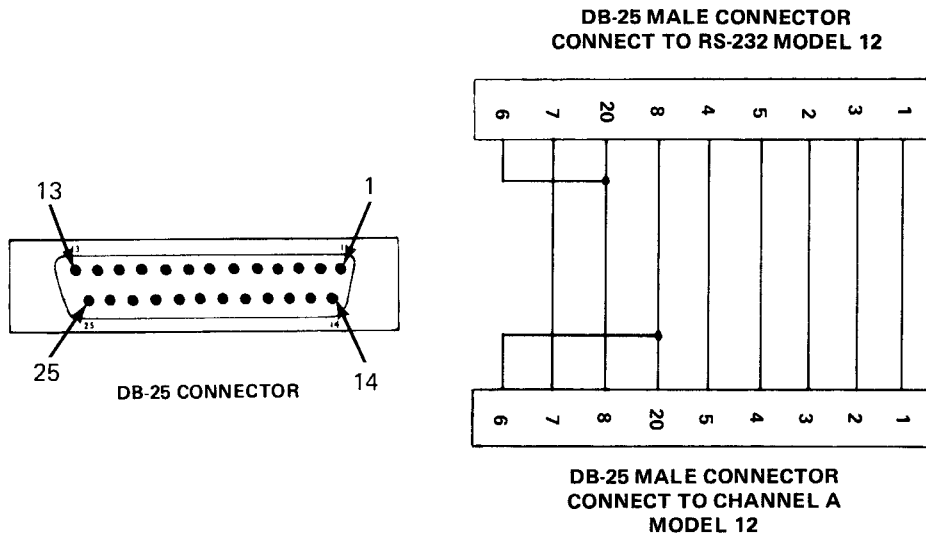

Connection Diagram, Model 12 (Channel A or B) to Model 12 (Channel A or B). Use stranded wire, 24-gauge, to connect two DB-25 connectors as illustrated. If the wire length exceeds 50 feet, twist Lines 7 (GND), 2 (TD), and 3 (RD).

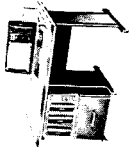

## APPENDIX

# Keyboard Code Map

The keyboard map (see foldout page) presents the actual code that TRSDOS will return to the user for each key on the keyboard, in each of the four modes-- unshift, shift, caps, and control.

A program executing under TRSDOS --for example, BASIC-- may translate some of these codes into other values. Consult the program's documentation for details.

Note: The **BREAK** key (code X'03') is always intercepted by TRSDOS. It will never be returned as a character to the user.

ESC 1B	! 21 1 31	@ 40 2 32	# 23 3 33	\$ A4 4 34	% 25 5 35	^ 5E 6 36	& 26 7 37	* 2A 8 38	( 28 9 39	) 29 0 30	- 7F _ 5F	+ 2B = 3D	BACK SPACE 08	BREAK 03
TAB 09	Q 11 51 71	W 17 57 77	E 05 45 65	R 12 52 72	T 14 54 74	Y 19 59 79	U 15 55 75	I 09 49 69	O 4F 4F 6F	P 10 50 70	[ 5B { 7B	] 5D } 7D	BACK SPACE 08	HOLD 00
CTRL LOCK	A 01 41 61	S 13 53 73	D 04 44 64	F 06 46 66	G 07 47 67	H 08 48 68	J 0A 4A 6A	K 0B 4B 6B	L 0C 4C 6C	: 3A ; 3B	" 22 ' 27	ENTER 0D	SHIFT	REPEAT
CAPS SHIFT	Z 1A 5A 7A	X 18 58 78	C 03 43 63	V 16 56 76	B 02 42 62	N 0E 4E 6E	M 0D 4D 6D	< 3C , 2C	> 3E - 2E	? 3F / 2F	SHIFT	REPEAT	SHIFT	REPEAT

20

## LEGEND:

XX	CONTROL
XX	SHIFT
XX	CAPS
XX	UNSHIFT

← 1C	7	8 38	9 39	F1 01
→ 1D	4 34	5 35	6 36	F2 02
↑ 1E	1 31	2 32	3 33	ENTER 0D
↓ 1F	0 30		. 2E	

Application programs	28	FCOPY	4
BACKUP	4,19	Floppy drive	
TRSDOS-II		Efficiency	57-59
System		Maintenance	42
Diskette	20-21,45	Thinline Patch	34-35
Data Diskettes	46-47	FORMAT	5,37-38
TRSDOS		Hard Disk	
System		Preparation	39-40
Diskette	22-25,48	TRSDOS Programs	39
Data Diskettes	49-50	TRSDOS-II Programs	39
BASIC	28-30	Backup library	40
Boot Error Table	77-80	HELP	5,59-60
Brightness control	8	Installation	
Contrast control	8	Model 12	13-14
COPY	4	Peripherals	15
Data, Safeguarding	25	KILL	5,60
DIR	4	Minimum System	
Disk Files	30-31	Diskette	61-63
Disk Format	30-31,37	Model 12	
Diskettes		Boot Errors	77-80
Care	41-42	Brightness control	8
Drive Maintenance	42	Communications	89
Inserting	9	Contrast control	8
Files	31	Drive light	8
Formatting	31,37-38	Features	1
Label	12	Installation	13-14
Removing	32	Keyboard	10
Swapping	32	Keyboard Code Map	91
Write-protect notch	12	Power light	8
DRIVE	4,57-59	Power Switch	8
Drive light	8	Reset button	8
Error Messages	69-80	Specifications	81-89
		MOVE	5,55
		Optional equipment	12
		Operating Systems	27

Peripherals			
Installation	15	Swapping diskettes	32
Power light	8	Thinline patch	34-35
Power switch	8	TRSDOS	
Power Up	4,16-17	Backup	48-50
Power Down	4,17	Using TRSDOS 2.0b	34
Reset button	8	Patching TRSDOS	34-35
RESTORE	5,51-54	Thinline Patch	34-35
SAVE	5,51-54	TRSDOS-II	
Safeguarding Data	25	Application Programs	33
Startup message	18	Backup	45-47
Storing Information	30	Converting TRSDOS	
		Programs	36
		Error Messages	69-80
		Loading	18
		Minimum System	
		Diskette	61-63
		Using TRSDOS	
		Application	
		Programs	33