

PRT-MPF-IP

**PRINTER
OPERATION
MANUAL**

COPYRIGHT

Copyright © 1983 by MULTITECH INDUSTRIAL CORP. All rights reserved. No part of this publication may be reproduced, transmitted, transcribed, stored in a retrieval system, or translated into any language or computer language, in any form or by any means, electronic, mechanical, magnetic, optical, chemical, manual or otherwise, without the prior written permission of MULTITECH INDUSTRIAL CORP.

DISCLAIMER

MULTITECH INDUSTRIAL CORP. makes no representations or warranties, either express or implied, with respect to the contents hereof and specifically disclaims any warranties or merchantability or fitness for any particular purpose. MULTITECH INDUSTRIAL CORP. software described in this manual is sold or licensed "as is". Should the programs prove defective following their purchase, the buyer (and not MULTITECH INDUSTRIAL CORP., its distributor, or its dealer) assumes the entire cost of all necessary servicing, repair, and any incidental or consequential damages resulting from any defect in the software. Further, MULTITECH INDUSTRIAL CORP. reserves the right to revise this publication and to make changes from time to time in the content hereof without obligation of MULTITECH INDUSTRIAL CORP. to notify any person of such revision or changes.



OFFICE/
15FL, 135 CHIEN KUO N. ROAD, SEC. 2, TAIPEI
10479, TAIWAN, R.O.C.
TEL: (02) 505-5533
TELEX: 19162 MULTIC FAX: (02) 505-4451
FACTORY/
1 INDUSTRY, ROAD, III,
HSINCHU SCIENCE-BASED INDUSTRIAL PARK
HSINCHU, TAIWAN 300, R.O.C.

TABLE OF CONTENTS

CHAPTER 1	INTRODUCTION	1
CHAPTER 2	INSTALLATION PROCEDURE	3
CHAPTER 3	PRT-MPF-IP SPECIFICATIONS	7
3.1	Hardware Specifications	7
3.2	Function of Monitor Program	8
CHAPTER 4	THEORY OF HARDWARE CIRCUIT	9
4.1	PRT-MPF-IP Hardware Circuit	9
4.2	PRT-MPF-IP Pin Function P1	10
4.3	MTP201A	12
4.4	Timing Chart of MTP201A	13
4.5	Theory of Operation	14
CHAPTER 5	GENERAL CONCEPTION	18
5.1	Monitor Program of PRT-MPF-IP	18
5.2	Monitor Subroutines	18
5.2.1	Summary	18
5.2.2	SHIFT	19
5.2.3	PLINEFD	19
5.2.4	PLINE	20
5.2.5	MTPPRT	21
5.2.6	Printer Driver Utility MTPPRT	22

Note to Users

- 1) Please take note that the power is supplied to the PRT-MPF-IP via a 9V, 1A AC adapter.

An AC adapter is provided for the MPF-IP and each of MPF-IP's option boards such as the PRT-MPF-IP, SSB-MPF-IP, SGB-MPF-IP, etc. Please don't replace that for the PRT-MPF-IP with those for other optional boards.

If the electrical current supplied to the PRT-MPF-IP is less than 1A, the thermal printer will not be activated. Moreover, insufficient power may cause damage to the PRT-MPF-IP.

- 2) Because of a lack of ULN2803A on board location U3, an ULN2003A, MPSA13 transistor, and a 4.7K resistor are used in place of ULN2803A on the printed circuit board (PCB) (Version 6)

The version number of the PRT-MPF-IP PCB is printed in the center of the PCB such as

PB8201910-6B

Version 6

└─ This digit tells you the version number of the PRT-MPF-IP. If the digit here is 4, then the PCB version is 4. If it is 5, then the version is 5.

- 3) If the version number of your PRT-MPF-IP is 4 or 5, please refer to the circuit diagram for ULN2803A (U3) in the schematic.

If the version number of your PRT-MPF-IP is 6, please refer to the circuit diagram for ULN2003A (U3) in the schematic.

ABOUT THE POWER ADAPTER FOR PRT

The power adapter to be used with the MPF-IB, MPF-IP, and most of its optional boards is of 9V/600 mA. However, the power adapter for the PRT-MPF-IP outputs power of 9V at 1A. This is because that the motor starting current for the PRT-MPF-I and PRT-MPF-IP is 700 mA, which plus the current consumed by the printed circuit board of the PRT itself, causes the current on the PRT to achieve as high as 900 mA while the PRT is being activated. Thus, the PRT needs a power adapter which can output power of 9V at 1A.

WARNING

1. It is possible that some users frequently plug the wrong power adapter to the PRT. If you do plug the wrong power adapter to the PRT, you are running the risk of damaging your PRT.
2. When the PRT is not operating as it is expected (such as printing a long colored band), the user has to disconnect the power adapter immediately. Otherwise, the printer will be damaged.

REASONS WHICH LEAD TO THE DAMAGES OF THE PRINTER HEAD

1. If power adapter whose output power is less than 9V/1A is used for driving the printer, usually the printer will not be activated. Even if the printer is activated, the printer may stop after printing a few characters or a long colored band. The printer head may be damaged if power is still applied to the PRT.
2. When a user does not understand the theoretical background of the operation of the PRT, programming the I/O port for the PRT improperly will stop the operation of the printer. If the power adapter plugged to the PRT is not disconnected in time, this will also lead to the damage of the printer head.
3. Strictly follow the installation procedures for connecting the PRT to the MPF-IB or MPF-IP. If the user plugs the power adapters to the MPF-IP (or MPF-IB) and the PRT, respectively, without connecting the PRT to the MPF-IP (or MPF-IB) first, this will stop the PRT and damage the printer head.

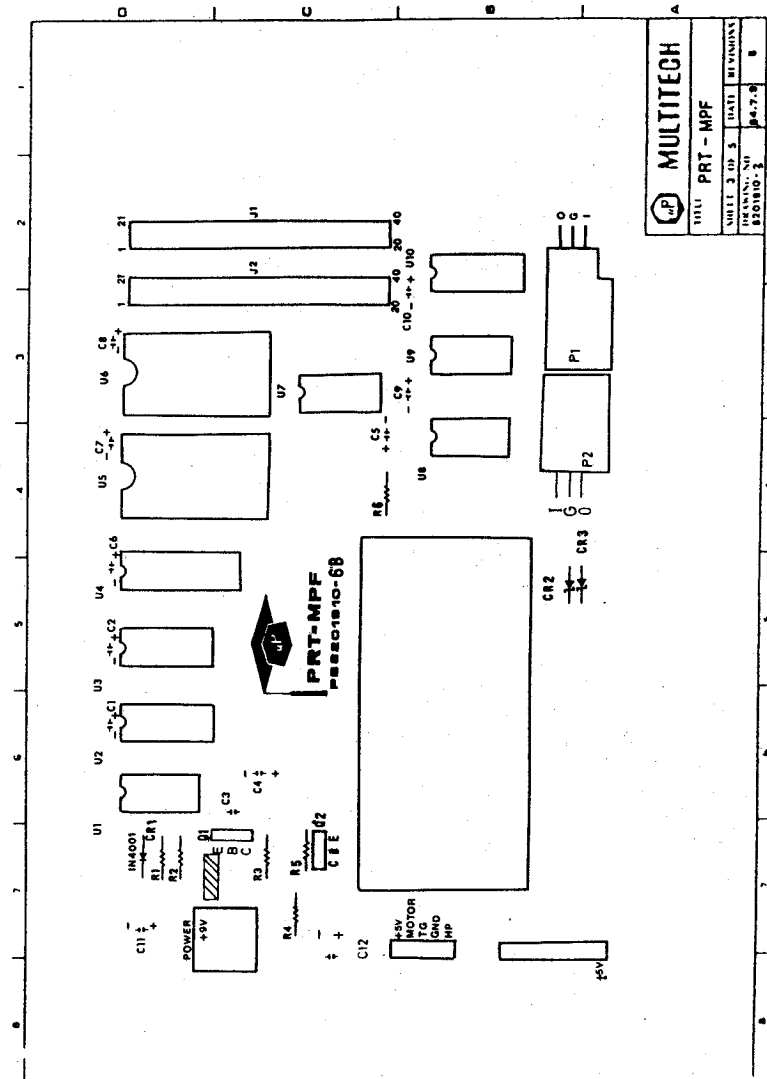

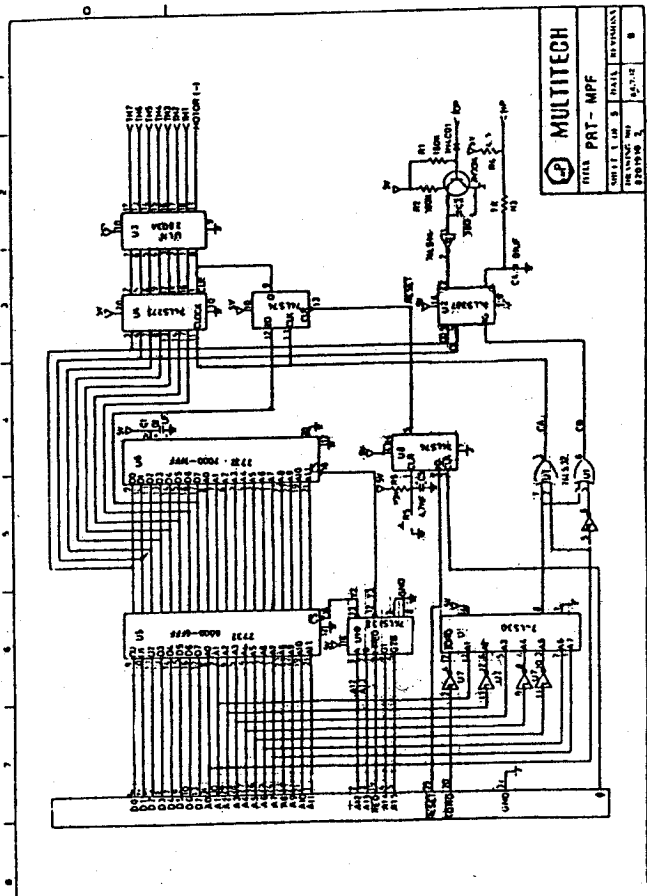

MULTITECH	
TITLE: PRT - MPF	
DESIGNED BY:	DATE:
DRAWN BY:	DATE:
CHECKED BY:	DATE:
APPROVED BY:	DATE:

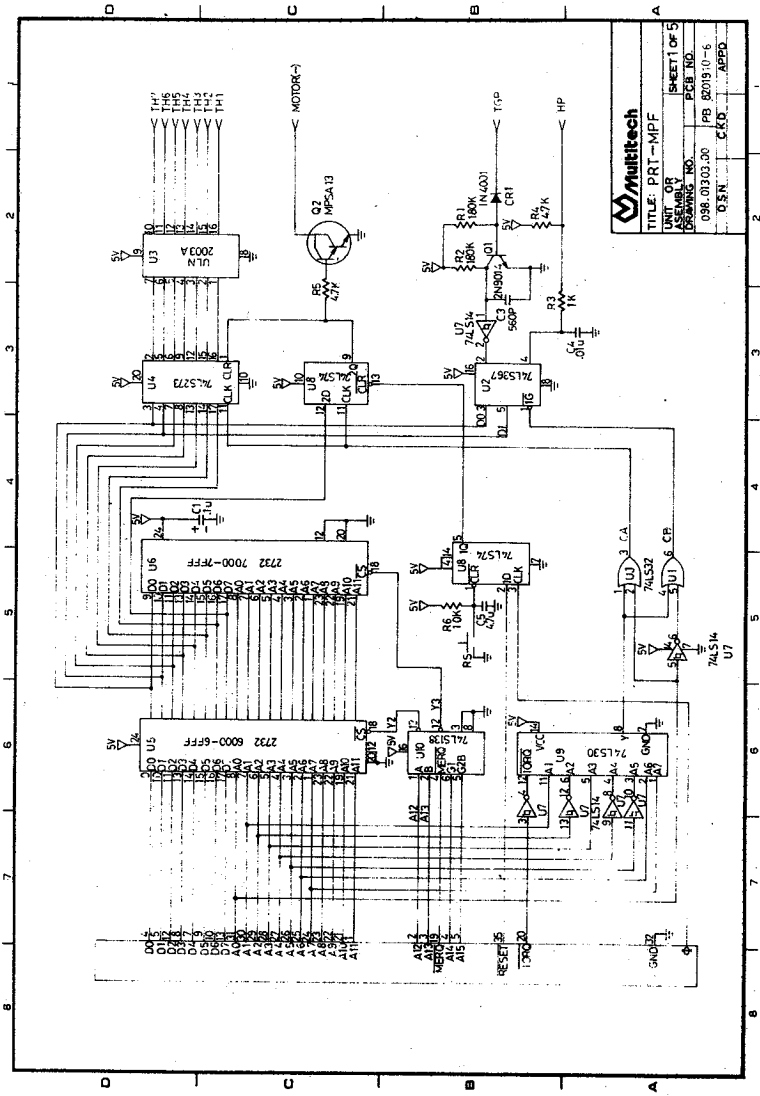

Multitech	
TITLE: PRT - MPF	
UNIT OR	SHEET 1 OF 5
DESIGN NO.	DATE:
098 0303 00	PB 8008 U-5
CSN	CHKD
	APPD

CHAPTER 1 INTRODUCTION

The printer for Multitech's MPF-IP microcomputer (PRT-MPF-IP) is a small, low cost PC board on which a micro thermal printer is built. This optional peripheral enables your MPF-IP to perform the printing function.

With your PRT-MPF-IP, you can print out data and programs processed by your MPF-IP as a form of permanent record at extremely low cost.

The printer board can be interfaced to MPF-IP microcomputer with a flat 40 pins connector cable, which is provided by Multitech or its worldwide distributor network. To activate your PRT-MPF-IP, you have to provide a power input of +9V/1A to it using a power adaptor which requires power input of either 110V or 220V.

The PRT-MPF-IP is controlled by a single +5V EPROM 2732 which has a memory totaling 4K bytes. Since the monitor is programmable, you can design your own printer interface board by changing the monitor chip of your PRT-MPF-IP. By doing so, you can familiarize yourself with the interfacing principles between microprocessor and printers. This is one of the unique features of PRT-MPF-IP.

The PRT-MPF-IP is very compact—only 11.15 cm wide and 15.40 cm long. It can be fitted easily into the package of MPF-IP microcomputer.

The PRT-MPF-IP uses a micro thermal printer (MTP201A). It's mechanical specifications are as follows:

- a. Dimensions: 70mm (W) x 33mm (D) x 14.4mm (H)
- b. Weight: 45 grams
- c. Number of characters per line:
20 characters/138 dots
- d. Width of printing per line: 46mm
- e. Size of characters:
2 x 1.7mm (5 x 7 dot matrix) each character
- f. Space between lines: 1.8+0.4mm
- g. Width of paper: 58mm
- h. Tention of paper feed: more than 20 g
- i. Printing speed:
Approximately 0.8 line/per second (when the voltage of motor is 5V)
- j. Life of printer:
500,000 lines (at standard printing test condition)

The printing method of PRT-MPF-IP is as follows:

- a. Principle: thermal serial method
- b. Printing direction: from left to right
- c. Printing timing:
tacho-generator synchronized method

The power source of the printer board PRT-MPF-IP is 5 +1V.

CHAPTER 2 INSTALLATION PROCEDURE

1. All power should be turned off.
2. Connect the CPU BUS of MPF-IP with P1 on the PRT-MPF-IP by flat cable.
3. Plug in the MPF-IP power plug.
4. Plug in the PRT-MPF-IP power plug.
5. Set up the thermal paper
 - a. Unwrapped the thermal paper roll and put the paper roll as illustrated.

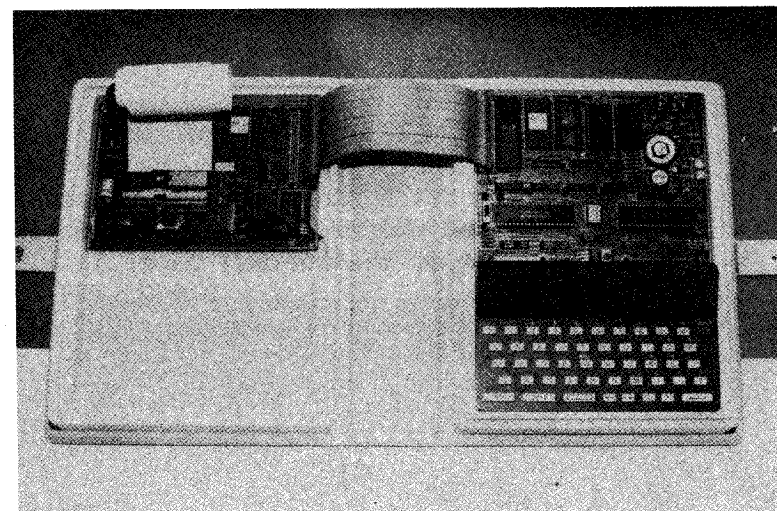

b. Locate the thermal head.

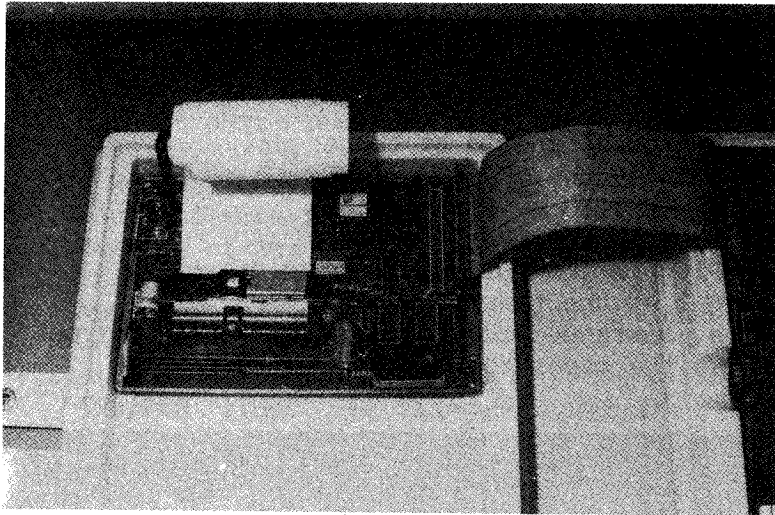

c. Cut the thermal paper into an acute edge to make it easier to insert the thermal paper. (Note: A sharp edge is necessary to keep the thermal head from hindering the passage of the thermal paper.)

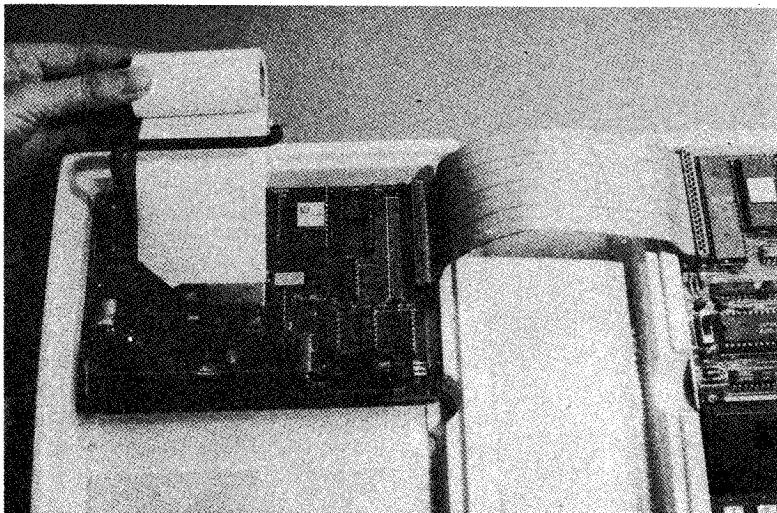

d. Slip the thermal paper into the slit at the bottom of the thermal printer as illustrated. Push the paper band until the tip of the thermal paper rolls from the slit under the paper cutter.

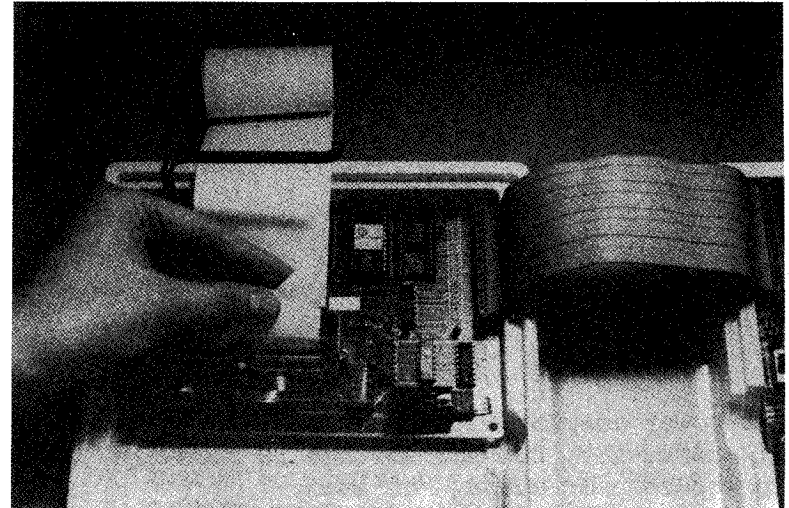

e. Locate the L-shaped paper support and screw it clockwise into the brass chassis on the PRT board.

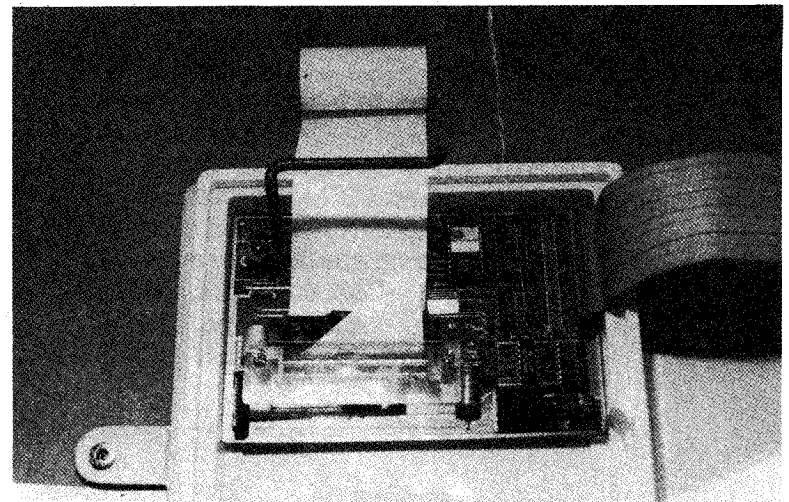

- f. Put the thermal paper roll on the paper support.

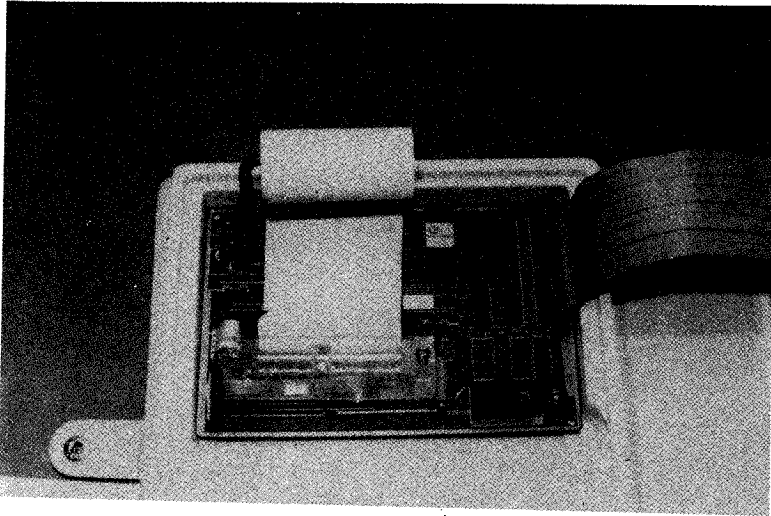

6. As power adaptor output has no load, the voltage is about 13V, but the voltage is about 10V when power adaptor output has load.

CHAPTER 3 PRT-MPF-IP SPECIFICATIONS

3. 1 Hardware Specifications

1. Compatible with MPF-IP. Use 40 pins flat ribbon cable and male connector to interface with MPF-IP.
2. ROM: (Read Only Memory)
Single +5V EPROM 2732 x 1, total 4K byte.
Monitor EPROM Address: 6000-6FFF.
3. Memory expansion area:
Single +5V EPROM 2716/2732, total 2K (4K) bytes. On-Board Expansion Address: 7000-7FFF.
4. Display: MPF-IP display.
5. Keyboard: MPF-IP keyboard compatible.
6. System Power Consumption: +5V/350mA.
7. Main Power input: +9V/1A adaptor is provided, power adaptor input 110/220V.
8. Interface Connector/Cable: 40 pins flat ribbon cable and male connector used for interfacing to MPF-IP.
9. Extension Connector area: 40 pins flat ribbon cable male connector area provides the bus for CPU option.
10. Printer:
Micro thermal printer MTP201A is a high performance thermal printer manufactured by the DAINI SEIKOSHA CO.
11. Physical Characteristic:
Height: 1.6 cm
Width: 11.15cm
Depth: 15.4cm

3. 2 Function of Monitor Program

1. Built-in alphanumeric character patterns.
2. Built-in printer drive utility.
3. Built-in MPF-IP memory dump utility.
4. Built-in Z80-Disassembler listing utility.

CHAPTER 4

THEORY OF HARDWARE CIRCUIT

4. 1 PRT-MPF-IP Hardware Circuit

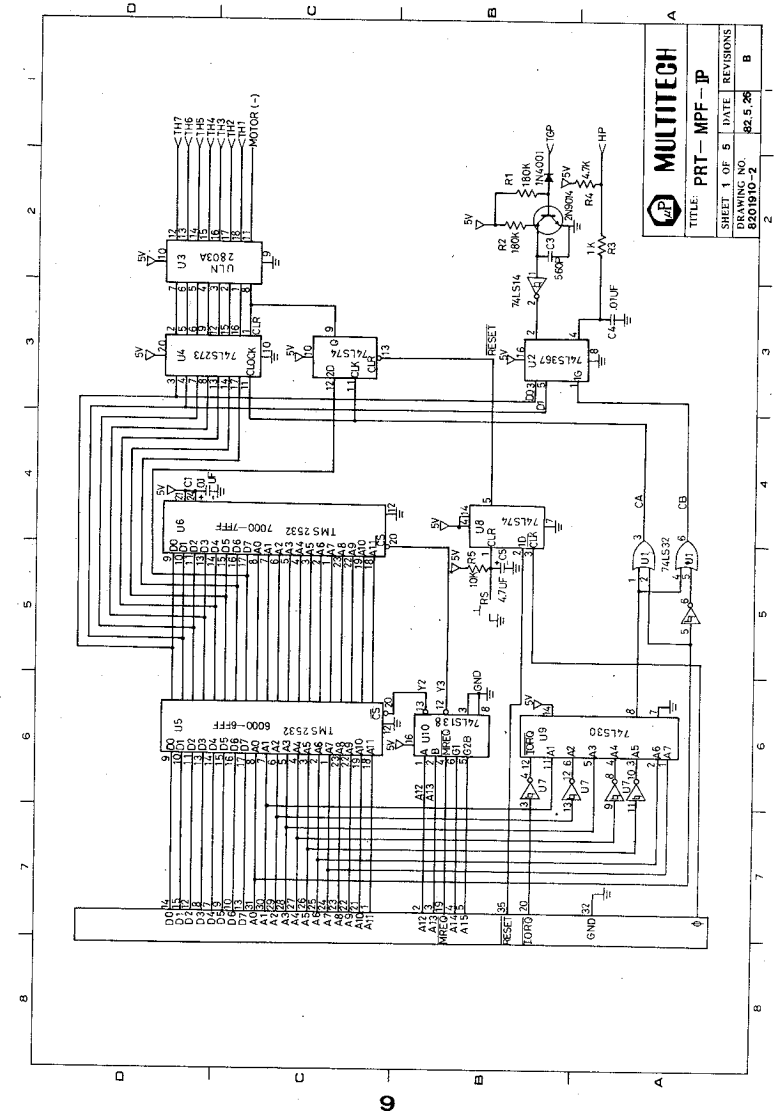

MULTITECH	
TITLE: PRT-MPF-IP	
SHEET 1 OF 5	DATE
DRAWING NO. 8201910-2	REVISIONS
	82.5.26
	B

4. 2 PRT-MPF-IP Pin Function P1

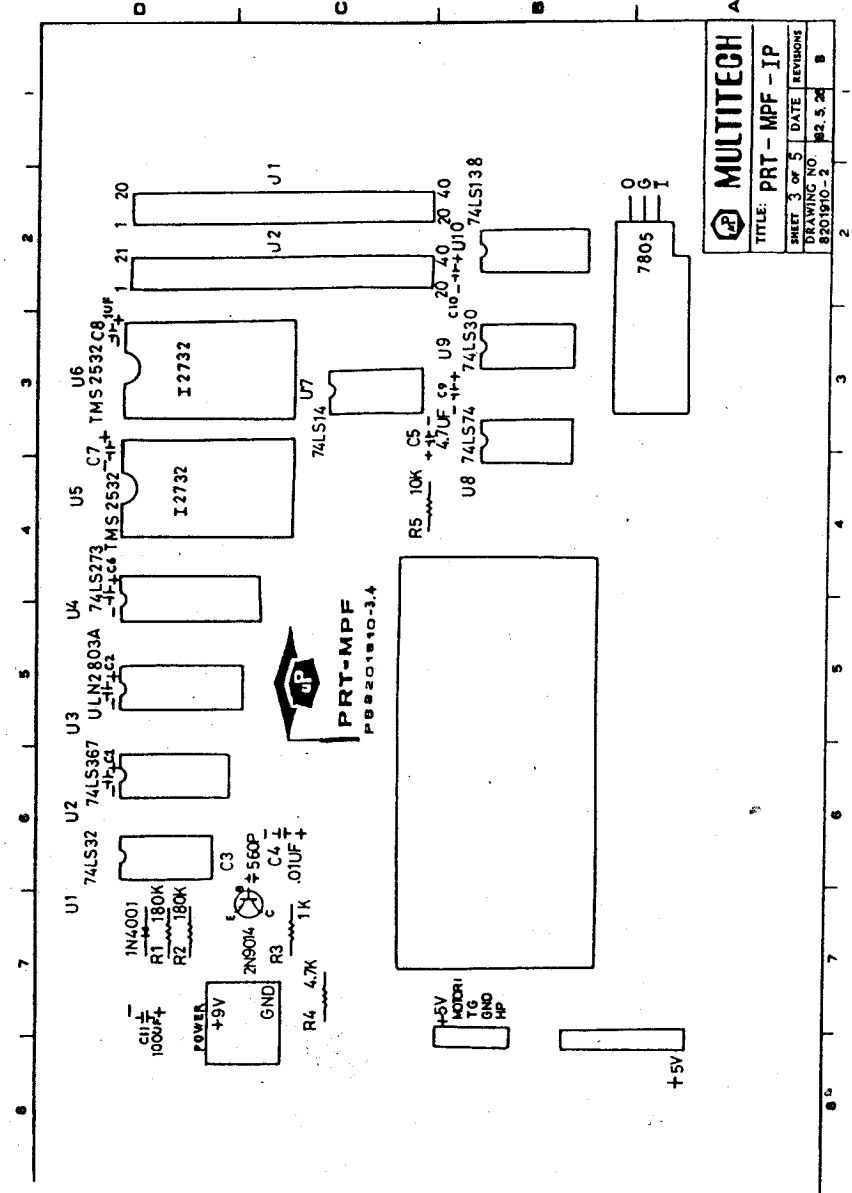
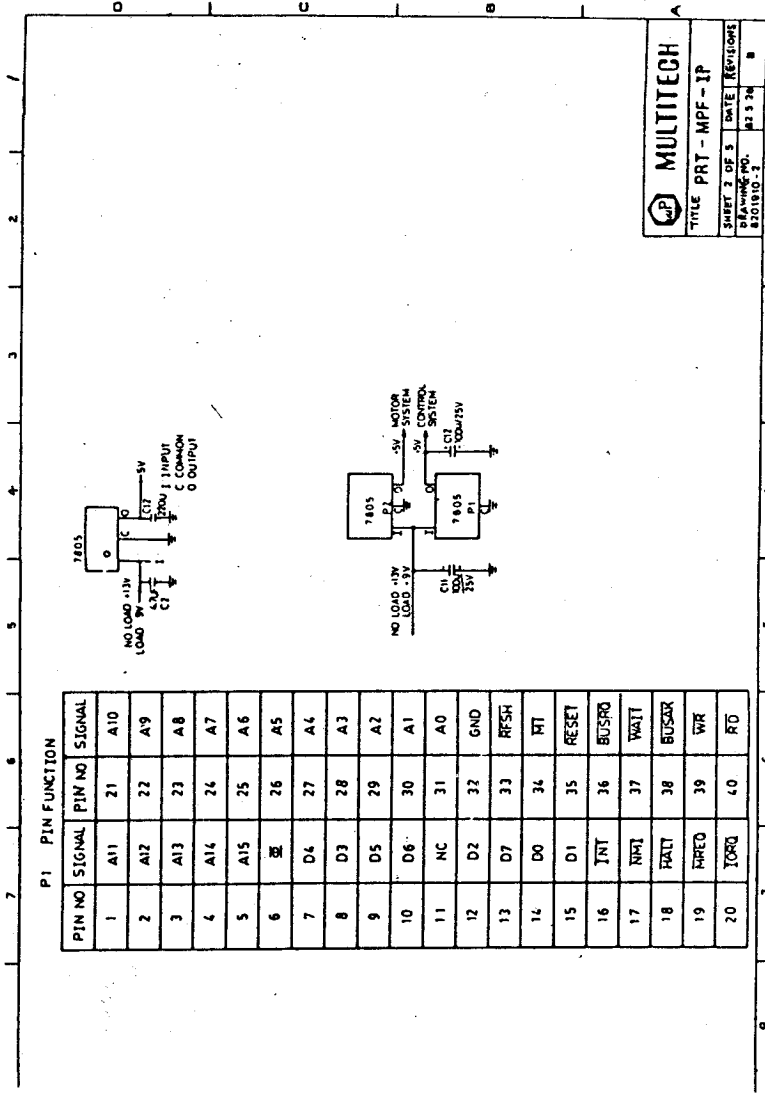

4. 3 MTP 201A

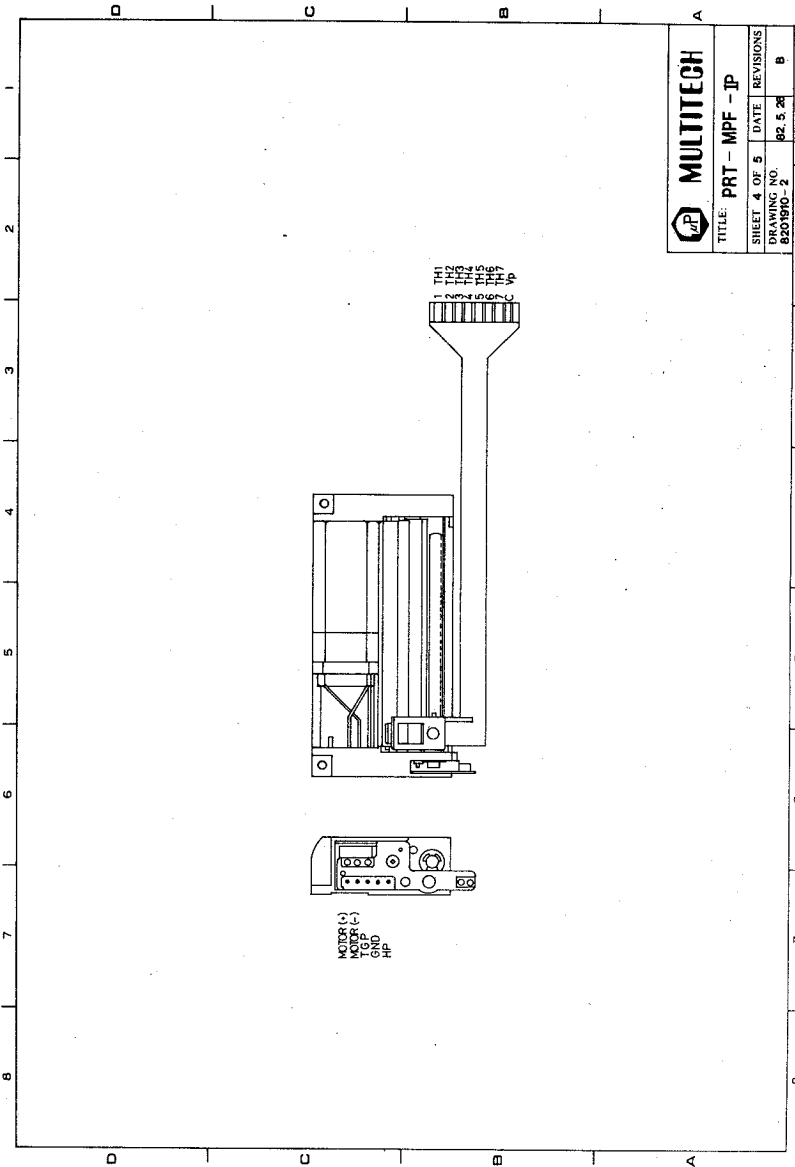

4. 4 Timing Chart of MTP201A

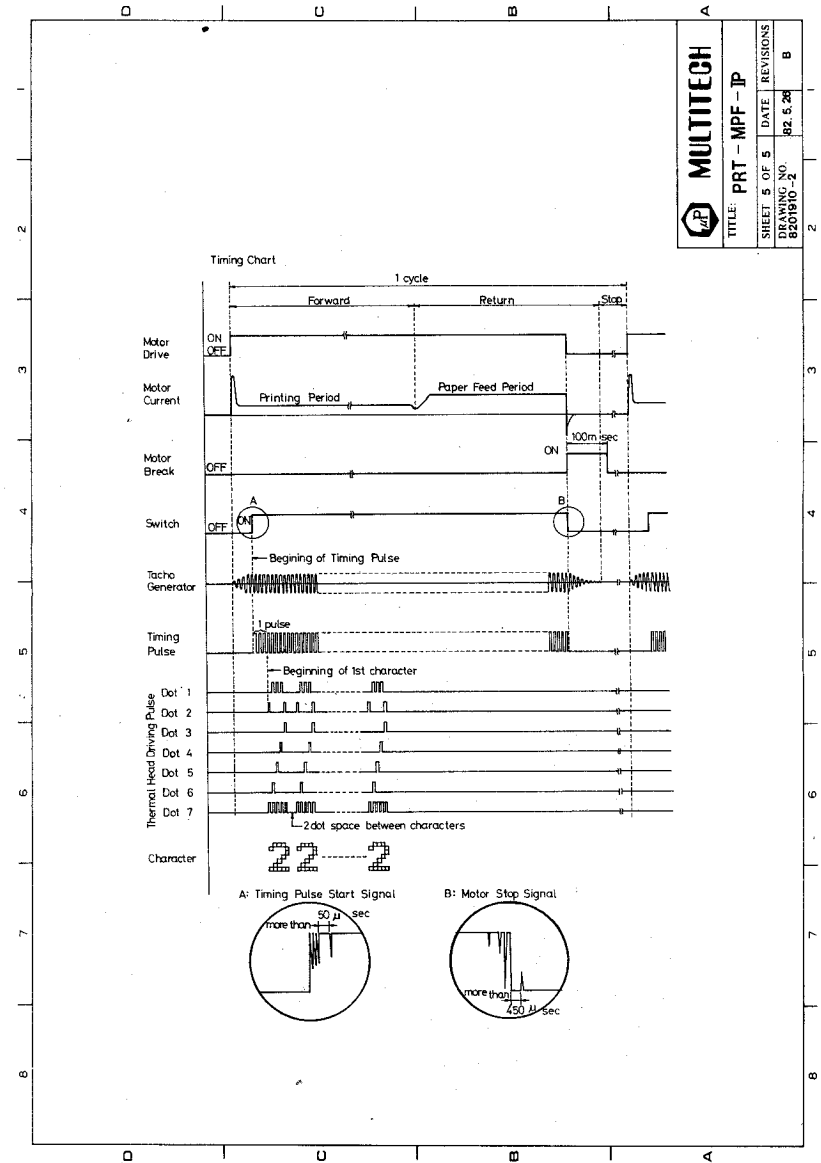

4. 5 Theory of Operation

1. Printing Method

- (1) Principle
Thermal serial method
- (2) Printing Direction
From left to right
- (3) Printing Timing
Tacho-generator synchronized method
- (4) Home Detecting method
The switch is off when the head comes to the left position.
The motor shall stop when the switch turns off (110 usec Low Level detecting).
Printing shall start when the switch turns on (50 usec High Level detecting).
(1 dot space)

2. Characteristics of Motor Drive

- (1) Voltage of Power Source:
5 + 1V
- (2) Current Consumption of Motor:
Less than 170 mA while printing.
(at standard temperature and standard relative humidity)
Less than 250 mA while paper feeding.
(at standard temperature and standard relative humidity)
- (3) Motor Starting Current:
700 mA max. (DC 5V)
- (4) Brake Current:
500 mA max. (DC 5V)
- (5) Motor Stop Time:
60 msec typ. (at the rated load of 5V)
max. 100 msec (at the min. load of 6V)
- (6) Motor Stop signal:
Within 1 msec after a switch is OFF.

3. TG Output Characteristics

- (1) TG Output Voltage:
5V p-p (at rated load of 5V)
max. 9V p-p (at the min. load of 6V)
min. 2V (at the max. load of 4V)
- (2) TG Period:
4 msec (at the rate load of 5V)
max. 8 msec (at the max. load of 4V)
min. 2.5 msec (at the min. load of 6V)
- (3) Internal Resistance:
100 - 500

4. Characteristics of Switch

- (1) OFF Time
TG Output: more than 8 cycles
- (2) Contact Resistance
Less than 10 (at the current of 5
50 uA)
- (3) Current
1 mA max. (5 V DC max.)

5. Summary

- (1) The printer prints on heat sensitive roll paper by means of seven thermal elements, which can print 5 x 7 matrix dot characters. The seven thermal elements are mounted in fixed position on a moveable thermal head. During a print cycle, the thermal head is driven from left to right in a horizontal line. The individual thermal elements are turned on for discrete intervals during the thermal head movement forming the partial characters. The printed characters formed by dot patterns stored in the PRT-MPF-IP monitor. After a row of characters has been printed, the motor driven platen advances the paper vertically by one line.
- (2) When the thermal head is turned on, the

printer will print by means of the state of the seven thermal elements. Thermal element TH1-TH7 are controlled by ULN2803A. When the output of ULN2803A is high, the thermal element is turned off and will not print.

- (3) The motor speed is depended on the voltage source.
- (4) The content of memory address 6AE3H controls the intensity of the printer. The typical value is 18H, the user may change 18H to 19H or 1AH. This will imprve intensity of the printer. Of course, the intensity of the printer will be decreased as changing 18H to 17H or 16H.

CHAPTER 5. GENERAL CONCEPTION

5. 1 Monitor Program of PRT-MPF-IP

1. The user's stack pointer of MPF-IP is 0FEA0H.
2. The system stack pointer of MPF-IP is 0FED0H.
3. The system RAM areas of PRT-MPF-IP monitor is FFBE-FFD2.

5. 2 Monitor Subroutines

5.2.1 Summary

<u>ADDRESS</u>	<u>MNEMONIC</u>	<u>FUNCTION</u>
6A00	SHIFT	Drive the thermal head shift right
6A10	PLINEFD	Line feed
6A30	PLINE	Drive the paper vertically by two lines
6A40	MTPPRT	Print out the contents of line buffer

5.2.2 SHIFT

[Address]: 6A00

[Function]: Drive the thermal head to shift right.

[Input]: Delay time depends on register B.

[Output]: Printer head shifts to the right.

[Register]: Destroy A,B, only.

Example: Drive the printer head to shift right 1cm.

```

                                SHIFT EQU 6A00H
FB00                                ORG 0FB00H
FB00 0645                          LD B,45H
FB02 CD006A                         CALL SHIFT
FB03 76                             HALT

```

5.2.3 PLINEFD

[Address]: 6A10

[Function]: line feed

[Input]: None

[Output]: Drive the paper vertically by one line.

[Register]: Destory A, B only.

Example: Drive the printer vertically by one line print out the message "LINE FEED" and feed the line twice.

```

        PLINEFD EQU 6A10H
        MTPPRT  EQU 6A40H
FB00    CD106A   ORG 0FB00H
FB00    DD2111FB CALL PLINEFD
FB03    CD406A   LD IX,PAT
FB07    CD406A   CALL MTPPRT
FB0A    CD106A   CALL PLINEFD
FB0D    CD106A   CALL PLINEFD
FB10    76       HALT
FB11    4C494E45 PAT DEFM 'LINE FEED'
FB1A    0D       DEFB 0DH

```

5.2.4 PLINE

[Address]: 6A30

[FUNCTION]: Drive the paper vertically by two lines.

[Input]: None

[Output]: Drive the paper vertically by two lines.

[Register]: Destroy A, B, only.

Example: Drive the printer to print out the message "LINE" and feed twice.

```

        PLINE EQU 6A30H
        MTPPRT EQU 6A40H
FB00    DD210BFB ORG 0FB00H
FB00    CD406A   LD IX,PAT
FB04    CD406A   CALL MTPPRT
FB07    CD306A   CALL PLINE
FB0A    76       HALT
FB0B    4C494E45 PAT DEFM 'LINE'
FB0F    DEFB 0DH

```

Example: The ASCII code 0A is a line feed code, so the following program is the same as the above program.

```

        MTPPRT EQU 6A40H
FB00    DD2108FB ORG 0FB00H
FB00    CD406A   LD IX,PAT
FB04    CD406A   CALL MTPPRT
FB07    76       HALT
FB08    4C494E45 PAT DEFM 'LINE'
FB0C    DEFB 0AH
FB0D    DEFB 0AH
FB0E    DEFB 0DH

```

5.2.5 MTPPRT

[Address]: 6A40

[Function]: Print out the contents of line buffer.

[Input]: IX points to the line buffer.

[Output]: Print the contents of line buffer out.

[Register]: Destroy AF', B'.

Example: Print out the message "MY NAME IS PRT-MPF-IP".

```

        MTPPRT EQU 6A40H
FB00    DD2108FB ORG 0FB00H
FB00    CD406A   LD IX,PAT
FB04    CD406A   CALL MTPPRT
FB07    76       HALT
FB08    4D59204E PAT DEFM 'MY NAME IS PRT-MPFIP'
FB1C    0D       DEFB 0DH

```

5.2.6 Printer Driver Utility MTPPRT:

[Address]: 6A40

The following procedures instruct user how to implement the utility in order to print out data in line buffer.

1. Set IX points to the line buffer (the starting address of the line buffer can be printed from the line you appoint).
2. The data length in line buffer could be stretched as you want but each row should be separated by 0AH and the characters in every row can't be more than 20.
3. The end of the line buffer should be terminated by an ASCII code 0DH.
4. The data in line buffer should be ASCII code only (0A, 0D and 20-5F).
5. The ASCII code 0AH stands for line feed.
6. The ASCII code 09 stands for TAB code.
7. If users want to use this Driver Utility with another microcomputer system, the system must be Z80 CPU based computer system.