

T 3 2 0 0

P E R S O N A L C O M P U T E R

OWNER'S MANUAL

TOSHIBA

T3200

OWNER'S MANUAL

The material in this manual is subject to change without notice. Despite every effort, in a manual of this scope, errors or omissions may occur. Therefore, TOSHIBA cannot be held responsible for any malfunctions or loss of data as a result.

T3200 Owner's Manual

(First Edition) August 1987

Copyright 1987 TOSHIBA Corporation

Preface

This manual explains how to use your T3200 portable personal computer.

This manual includes the following parts.

PART 1 INTRODUCTION

This part describes the features of the T3200 system and major components.

PART 2 PRECAUTIONS

This part describes general matters that demand special attention about environmental condition and handling.

PART 3 QUICK START

This part is a shortcut startup procedure for users who are familiar with personal computers.

PART 4 SETTING-UP

This part helps you set up the major components of the T3200.

PART 5 DISKS AND DISK DRIVES

This part introduces the T3200 storage devices and gives practical information about how to use them.

PART 6 OPERATION

This part explains operation of T3200 and general precautions to be taken when using a floppy disk.

PART 7 USING MS-DOS

This part introduces the MS-DOS operating system.

PART 8 TROUBLESHOOTING

This part helps you diagnose and resolve any problems which you might encounter when using the T3200.

PART 9 OPTIONS

This part provides a step-by-step installation guide for each of the optional units. Some of them will be provided with the optional units.

Contents

PART 1 INTRODUCTION

1.1	General	1
1.2	Computer Capabilities	2
1.3	Options	4
1.4	Features	5
1.5	Physical Dimensions	6

PART 2 PRECAUTIONS

2.1	Preparing Work Area	1
2.2	Environmental Requirements	1
2.3	Cleaning	3
2.4	Handling	3
2.5	Plasma Display	4
2.6	Vibration and Shock	4

PART 3 QUICK START

3.1	Quick Start Procedure	1
-----	-----------------------	---

PART 4 SETTING-UP

4.1	System Unit	1
4.2	System Unit Components	2
4.3	Switches and Connectors	4
4.4	Plugging-in AC Power Cord	8
4.5	Setting Up Keyboard and Display	10
4.5.1	Use of Plasma Display and External Keyboard	10
4.5.2	Use of CRT and External Keyboard	11
4.5.3	Use of Plasma Display and Internal Keyboard	11
4.6	A-B-PRT Switch Setting	12
4.6.1	No Printer, No External Drive	12
4.6.2	Printer, No External Drive	12
4.6.3	External Drive, No Printer	13
4.6.4	Both a Printer and an External Drive	13
4.7	Setting DIP Switch	14
4.8	Colour CRT Display Connection	16
4.9	Printer Connection	17
4.10	External Floppy Disk Drive Connection	18

PART 5 DISKS AND DISK DRIVE

5.1	Concepts	1
5.2	Disk Drive Options	1
5.3	Disk Drive Identifiers	2
5.4	Saving Data on Disk	3
5.5	Write Protecting Disks	3
5.6	3.5-inch Floppy Disk	4
5.6.1	Floppy Disk Handling Precautions	5
5.6.2	Disk Write Protection	6
5.6.3	Labeling Disk	7

5.7	5.25-inch Floppy Disk Drive Unit	8
5.7.1	Parts	9
5.7.2	Connecting System Unit	10
5.7.3	Power ON and OFF	10
5.7.4	Floppy Disk	11
5.7.5	Disk Handling Precautions	12
5.7.6	Disk Write Protection	12
5.7.7	Labeling Disks	13
5.7.8	Disk Insertion	13
5.7.9	Disk Removal	14
5.7.10	Connecting AC Adaptor	14

PART 6 OPERATION

6.1	Before You Begin	1
6.2	Turning Power ON	2
6.3	Power-on Self-test	3
6.4	Setup Execution	5
6.5	Loading MS-DOS	11
6.5.1	Loading MS-DOS from Floppy Disk Drive	11
6.5.2	Loading MS-DOS from Hard Disk Drive	13
6.6	Set Up Gray Scale	14
6.7	Keyboard	15
6.7.1	Soft Switches	17
6.8	System Initialisation	18
6.9	Disk Removal from Drive	19
6.10	Turning Power OFF	20

PART 7 USING MS-DOS

7.1	Starting MS-DOS	1
7.2	Entering Date and Time	3
7.2.1	Entering Date	3
7.2.2	Entering Time	5
7.3	Setting Up Gray Scale for Plasma Display	7
7.3.1	To Change Gray Scale	7
7.3.2	To Use XCHAD Menu	8
7.3.3	Command Mode	11
7.4	Changing Current Disk Drive	14
7.5	Using Keyboard	15
7.5.1	Data Keys	15
7.5.2	Correction of a Typing Mistake	17
7.5.3	Entering Command	17
7.5.4	Stopping Command Execution	18
7.5.5	Suspending Screen Output	18
7.5.6	Making Hard Copy of Screen Information	19
7.5.7	Restarting MS-DOS	19
7.6	Disk Files	20
7.6.1	Definition of File	20
7.6.2	File Names	21
7.6.3	Drive Designation	22
7.6.4	Global File Names	23
7.6.5	How MS-DOS Keeps Track of Your Files	24
7.7	Commands	25
7.7.1	Executing MS-DOS Commands	27
7.7.2	Internal and External Commands	28
7.7.3	DIR : Listing File Names	29
7.7.4	FORMAT : Initialising Disks	31
7.7.5	DISKCOPY : Making Backup Copies of Your Disks	36
7.7.6	COPY : Copying Files	40
7.7.6.1	Copying Files to Same Disk	40
7.7.6.2	Copying Files to Another Disk	42
7.7.7	RENAME : Changing File Name	44
7.7.8	TYPE : Displaying Contents of File	45

7.8	Device Error Message	46
7.9	Turning OFF System	48
7.10	Establishing National MS-DOS Disks	49
7.11	Using Hard Disk	52
7.11.1	Preparation	53

PART 8 TROUBLESHOOTING

8.1	Directions	1
8.2	Before the Troubleshooting	2
8.3	Power-on Self-test	2
8.4	Diagnostic Test	10
8.4.1	Loading Diagnostic Test	10
8.4.2	Diagnostic Test	18

PART 9 OPTIONS

9.1	General	1
9.2	System Kit	2
9.3	Keyboard	3
9.4	Memory Expansion Option	11
9.5	PC Floppy Link	11

PART 1 INTRODUCTION

This part describes features, system components, and options. This part contains the following sections.

1.1	General	1
1.2	Computer Capabilities	2
1.3	Options	4
1.4	Features	5
1.5	Physical Dimensions	6

1.1 General

The Toshiba Personal Computer T3200 (hereinafter referred to as T3200) is a compact size and light-weight transportable personal computer.

The T3200 operates with standard operating systems such as MS-DOS*, thus enabling various applications for word processing, spreadsheets and database management, and most of the popular IBM PC** programs.

* MS-DOS copyright by Microsoft 1983, 1984, all rights reserved.

** IBM and IBM PC are trademarks of the International Business Machines Corporation.

1.2 Computer Capabilities

The T3200 is composed of the system unit and some other internal and/or external option boards and devices. The system unit includes the following key components.

- o A powerful 80286-12 microprocessor chip operates at a clock rate of 12 megahertz.
- o 1 megabyte of random access memory (RAM) are standard, allowing you to run the most popular software packages without buying more memory.
- o An integrated 3.5-inch fixed disk drive contains 40 megabytes of data in fixed (non-removable) storage.
- o A double-sided, double-density, double-track (2DD) 3.5-inch floppy disk drive accommodates floppy disks that hold 720 kilobytes of information.
- o A high resolution Plasma Display with pixels of 720 in columns and 400 in rows.
- o A keyboard with 85 keys. For most applications it can be used exactly like a standard typewriter keyboard.
- o A parallel interface port serves two purposes. Through it you can connect any Centronics compatible printer. Alternatively, you can connect an external 5.25-inch floppy disk drive through this port.

- o A standard 9-pin RS232C serial port lets you connect the T3200 to a serial interface device.
- o An external RGB display connector means you can use standard colour monitors with the T3200.
- o A calendar clock backed-up with battery keeps the date and time current even when the T3200 is not powered on. The year is valid from 1980 to 2099.
- o A set of configuration switches let you easily select various computer options.
- o System Configuration setup by Setup program is preserved in battery backed up memory while T3200 is not in use.
- o A keyboard of IBM PC/AT can be used as external keyboard by connecting through keyboard connector.

1.3 Options

The T3200 offers various options for expanding its capability and for user convenience. The T3200 options include,

- o System Kit, with a 3.5-inch disk is provided for each of UK (United Kingdom), USA (United States), Germany, France, Spain, Scandinavia and Italy. This disk stores MS-DOS as the T3200 operating system, and diagnostics which effectively improves the T3200 reliability.
- o Key Cap Set, is provided for each of USA, Germany, France, Spain, Scandinavia, Italy and Switzerland. The T3200 standard is the UK version keyboard. A set of key caps needs to be replaced in order to reflect the corresponding system kit used.
- o An ac powered external 5.25-inch floppy disk drive allows the T3200 to read and write 5.25-inch floppy disks that are interchangeable with IBM PC/AT and compatible computers.
- o A 3 megabytes memory expansion card increases the T3200's RAM size to 4 megabytes. Your dealer can add this piggy-back card without occupying the expansion board slot.

1.4 Features

The basic T3200 is flexible and includes many user friendly features:

- o The keyboard is easy to use.
- o The adjustable display panel lets you choose the comfortable angle of operation.
- o The T3200 has a variety of useful indicator lights.
- o The date and time are kept by a battery powered calendar clock.
- o Hardware options are easily selected using the configuration switches, A-B-PRT switch and voltage switch.
- o The T3200 is IBM PC AT compatible, allowing you to run PC software.
- o The T3200 comes with this User's Manual and an MS-DOS Reference Manual.

1.5 Physical Dimensions

The physical dimensions (weight and size) of the T3200 system unit are as follows.

ITEM	DIMENSION
Weight	8.6 kilograms, or 19.0 pounds
Size	370 × 97 × 395 millimeters, or 14.5 × 3.8 × 15.6 inches (width × height × depth)

PART 2 PRECAUTIONS

This part describes environmental requirements, attention that should be paid on handling, and other aspects that the T3200 requires before you operate the system. This part is composed of the following sections.

2.1	Preparing Work Area	1
2.2	Environmental Requirements	1
2.3	Cleaning	3
2.4	Handling	3
2.5	Plasma Display	4
2.6	Vibration and Shock	4

2.1 Preparing Work Area

Choose an area that is most suitable for use of the T3200 as a work area. You will need a clean, firm and level work surface that is sturdy to hold your system and which is at a convenient height for typing.

2.2 Environmental Requirements

When you operate the system, the ambient temperature and relative humidity of the room should be within the following ranges.

CONDITION	AMBIENT TEMPERATURE	RELATIVE HUMIDITY
Operating	5 to 35 °C	20 to 80 %
Non-operating	-20 to 60 °C	5 to 90 %

PART 2 PRECAUTIONS

Rapid temperature and humidity change must be avoided. The system, including cables, must be set up in a location free or distant from:

- o Dust, moisture, extreme heat and direct exposure to sunlight.
- o Objects which radiate heat. These could cause cabinet damage and other problems.
- o Objects which yield a strong electromagnetic field. (Hi-Fi Loudspeakers etc.)
- o Liquids or corrosive chemicals.

Keep the area around the ventilation holes and the top of each system and optional device clear. Avoid violent shocks to, or vibrations of, the system and optional devices while it is in use or storage.

The system and optional devices should be completely assembled during use. If it is partially dismantled, it may cause accidents or electric shock.

2.3 Cleaning

Use dry soft cloths to clean up the cabinet of the system unit. For stains, use water or neutral detergent with soft cloth.

CAUTION

- ▶ Never use any insecticides or chemical products such as benzine or thinner to clean up the cabinet.
- ▶ Take care not to put insecticide on the cabinet.

2.4 Handling

- o Take care not to drop the system or peripherals on the floor.

CAUTION

An HDD light is ON when the built-in hard disk drive is selected. The light lasts ON for a several seconds even if the hard disk operation has finished.

2.5 Plasma Display

- o Plasma Display is switched OFF whenever the display panel is in the closed position even in the presence of system power. When the display panel is opened, the power returns to the display.
- o You may notice a small sound when the display is turned ON and OFF. This will be the Plasma Display charging up. After the screen is turned ON, it will take a few seconds to stabilise.

2.6 Vibration and Shock

The T3200 system unit is designed to be resistant to vibration and shock. However, giving a strong vibration or shock has to be avoided.

PART 3 QUICK START

This part is for experienced computer users. If you are familiar with how to use a computer, this part will allow you to begin using the T3200 within minutes of unpacking.

If you are new to computers, however, we strongly recommend that you read the PART 4 SETTING-UP and use this part as a reminder once you've become familiar with the steps.

3.1 Quick Start Procedure

1

3.1 Quick Start Procedure

This quick start procedure assumes:

- o You've unpacked the system unit.
- o You have the 3.5-inch MS-DOS operating system disk.

Follow these steps to quick start your T3200:

- (1) Insert the rectangular end of the cable into the AC IN jack on the back of the computer. The AC IN jack is next to the power switch on the right side of the system as you face it from the rear.
- (2) Insert the contoured three-prong end into a standard ac wall outlet.
- (3) Set the system unit on a flat surface with the label 'Personal Computer T3200' facing you.
- (4) Press the display panel latch on the front of the system unit and lift the display panel.

PART 3 QUICK START

- (5) Locate drive -A. It's the 3.5-inch internal floppy disk drive on the right side as you face the system unit from the front.
- (6) Turn the power switch on. The POWER switch is located on the back side, in the upper right corner as you face the rear of the machine.

The computer performs a power-on self-test. If your dealer prepared the fixed disk drive for you (and you do not have a system disk in drive -A), the system starts from drive -C.

- (7) If necessary, answer the date and time questions. Because the T3200 has a calender clock, you only need to type the date and time if they are incorrect. The following prompt appears:

```
C>_
```

- (8) If an error message appears instead of the date and time, you may need to prepare the fixed disk or run the configuration setup program.

You are ready to load software and get to work.

PART 4 SETTING-UP

Setup procedure for each part of the system unit and how to connect external devices are discussed here. This part contains:

4.1	System Unit	1
4.2	System Unit Components	2
4.3	Switches and Connectors	4
4.4	Plugging-in AC Power Cord	8
4.5	Setting Up Keyboard and Display	10
4.5.1	Use of Plasma Display and External Keyboard	10
4.5.2	Use of CRT and External Keyboard	11
4.5.3	Use of Plasma Display and Internal Keyboard	11
4.6	A-B-PRT Switch Setting	12
4.6.1	No Printer, No External Drive	12
4.6.2	Printer, No External Drive	12
4.6.3	External Drive, No Printer	13
4.6.4	Both a Printer and an External Drive	13
4.7	Setting DIP Switch	14
4.8	Colour CRT Display Connection	16
4.9	Printer Connection	17
4.10	External Floppy Disk Drive Connection	18

4.1 System Unit

After you have unpacked the system, remove all packing materials but save them for later use.

Place the system unit on your work surface. If you have any T3200 options and would like to install them now, see PART 9 OPTIONS. The system unit when taken out of the box appears as in the figure below.

Figure 4-1 System Unit

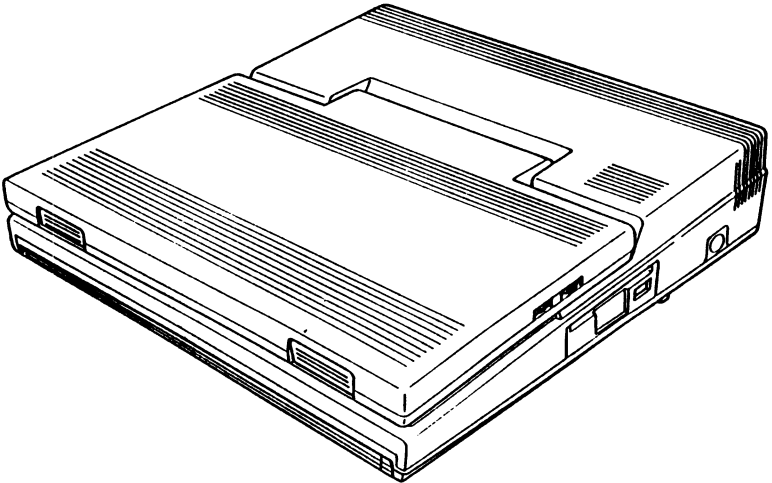

4.2 System Unit Components

To open the Plasma Display, push the latch and pull up the display. The display will then sit at any angle you like.

When the Plasma Display is pulled up, you can see the following components.

Figure 4-2 System Unit Components

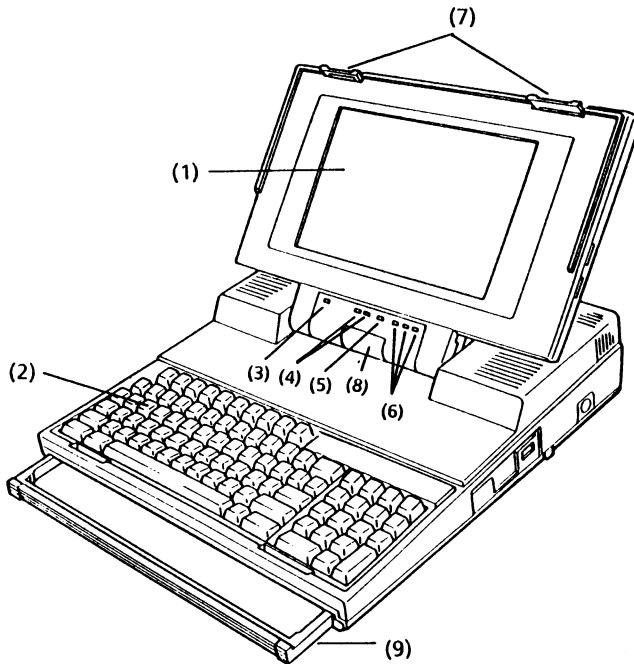

- (1) Plasma Display : Can display upto 720 horizontal pixels by 400 vertical pixels.
- (2) Keyboard : Has 85 keys including typewriter key area, the function keys and numeric keypad.
- (3) Power LED : When lit, ac power is being supplied to the system unit.
- (4) "Disk in Use" LEDs : An LED lights when a corresponding built-in floppy disk drive or hard disk drive is selected for use.
- (5) CRT LED : Indicates that a port to connect a colour CRT display is available to function.
- (6) Caps Lock, Num Lock, and Scroll Lock LEDs : An LED lights when the key corresponding to the LED is activated.
- (7) Plasma Display Latch : Holds the display firmly shut when the computer is closed and ready to carry. Release latch by pressing inward.
- (8) Hinge : Is designed to hold a Plasma Display at any angle to view.
- (9) Handle : It extends to form a convenient carrying grip for moving the computer around your office or home.

4.3 Switches and Connectors

The T3200 has a series of switches and connectors. Figure 4-3 shows the switches and connectors on rear panel, Figure 4-4 on page 4-6 shows the right side of the unit and Figure 4-5 on page 4-7 shows the left side of the unit.

Rear Panel

Figure 4-3 Switches and Connectors on Rear Panel

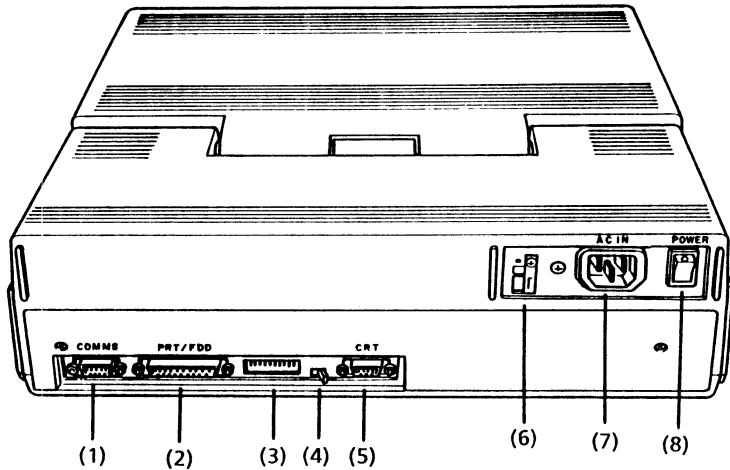

- (1) COMMS Connector : is a 9-pin D-Shell male connector used to connect an RS-232C external device.

- (2) PRT/FDD Connector : is a 25-pin D-Shell connector to attach a Parallel Printer for hard-copy printouts of information. This connector can also be used to connect a 5.25-inch external FDD instead of a printer. Setting the A-B-PRT Switch to PRT and DIP Switch 2 to ON makes this port general I/O port. By this, the port can connect an I/O device having the same pin configuration and capabilities as the printer.
- (3) DIP Switch : allows you to select various configuration options. These switches are called out individually when features they affect are discussed. Section 4.7 Setting DIP Switch provides a summary.
- (4) A-B-PRT Switch : changes over the addresses (-A or -B) of the floppy disk drives. Refer to Section 4.6 A-B-PRT Switch Setting for details.
- (5) CRT Connector : is a 9-pin D-Shell female connector to connect an RGB direct drive colour CRT display. The colour display from an IBM PC can be used.
- (6) AC IN Change Switch : is provided to adapt the power supply to the commercial ac power voltage. Adaptable voltage is 115 or 230 volts. Normally this switch is blanked off and access by a user is not allowed.
- (7) AC IN Jack : Supplies ac power to the computer. The power cord connects here.

- (8) POWER Switch : Turns the system unit power ON and OFF. When this switch is positioned downward the power is switched OFF, and when positioned upward the power is switched ON.

Right Side

Figure 4-4 Right Side Panel

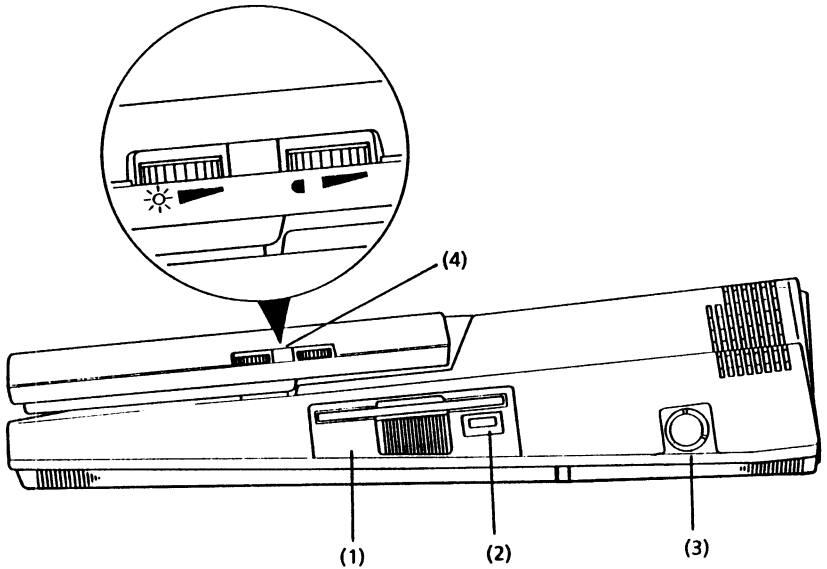

- (1) 3.5-inch Floppy Disk Drive
- (2) Disk Eject Button : Is used to eject a disk from the drive by pushing this button.

- (3) Keyboard Connector : Is used to connect an external keyboard.
- (4) Plasma Contrast/Brightness Dial : Controls the contrast or brightness of the Plasma Display screen. Adjust the angle of the screen first, then use the Plasma Display contrast/brightness dial to fine tune the display to your satisfaction.

Left Side

- (1) EXP. Slot : is protected by a cover that can be removed to allow installation of the expansion options.

Figure 4-5 Left Side Panel

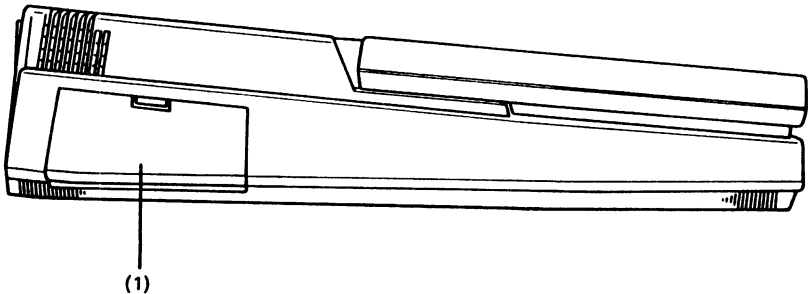

4.4 Plugging-in AC Power Cord

First, make a quick check of the universal voltage switch to be certain that it's set properly.

Then insert the power cord into the AC IN jack at the rear of the system unit.

Insert the contoured three-prong end of the cable into a standard ac wall outlet.

You will need wall outlet(s) for ac power connection. The required power source is:

Voltage : 115 (104 to 127) volts, or
230 (207 to 253) volts.

Frequency : 50 or 60 (49 to 61) herzs

CAUTION

Before plugging the power cord into the jack, make sure of the ac power voltage and confirm that the AC IN Change Switch reflects the voltage properly. If improper voltage were supplied, the T3200 power supply would irrevocably be damaged.

Figure 4-6 Plugging in the Power Cable

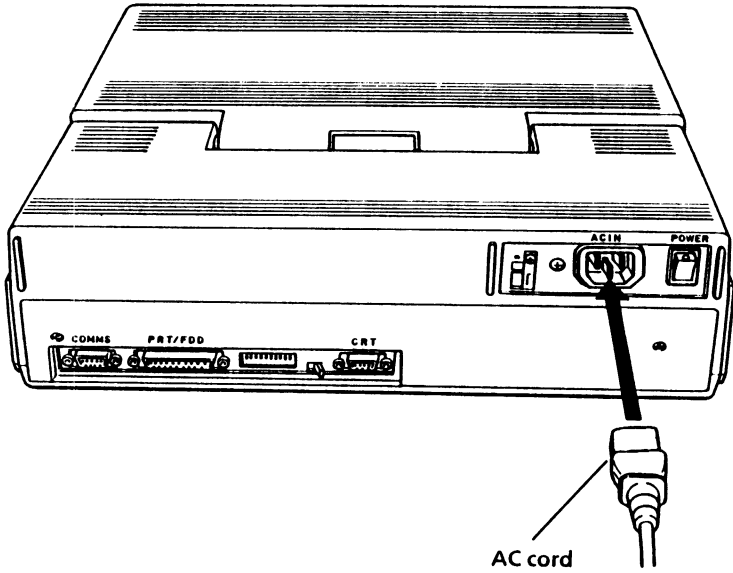

4.5 Setting Up Keyboard and Display

A keyboard of IBM PC/AT can be used as an external keyboard through the keyboard connector.

You can also use an external CRT through the CRT connector on rear panel.

The setting which keyboard you use an internal keyboard or an external keyboard is read at system initialisation time, turning ON the system unit power or system initialisation by a keyboard operation.

The setting which display you use an internal Plasma Display or an external CRT display with opening and closing the Plasma Display is also read at system initialisation time.

4.5.1 Use of Plasma Display and External Keyboard

To use the Plasma Display and the external keyboard, connect the external keyboard through the keyboard connector and open the Plasma Display Cover before turning system power ON or system initialisation by keyboard operation.

4.5.2 Use of CRT and External Keyboard

To use the CRT and the external keyboard, connect the external keyboard through the keyboard connector and close the Plasma Display Cover before turning system power ON or system initialisation by keyboard operation.

Note : If you turn system power ON or system initialisation without connecting CRT, you cannot have a display equipment even Plasma Display exists. Therefore you must press the **Fn + Home** return to the Plasma Display.

4.5.3 Use of Plasma display and Internal Keyboard

To use the internal keyboard and Plasma Display, disconnect the external keyboard through the keyboard connector and open the Plasma Display Cover.

If the external keyboard is not connected through the keyboard connector and the Plasma Display Cover is closed, it is impossible to use not only the external keyboard but also CRT. Therefore you use the internal keyboard and Plasma Display.

4.6 A-B-PRT Switch Setting

This switch changes over the addresses (-A or -B) of the Floppy Disk Drives (FDDs).

CAUTION

- ▶ This switch is usually set to the PRT position.
- ▶ The switch setting is read at system initialisation time, turning ON the system unit power or system initialisation by a keyboard operation. Thus if you have changed the switch setting, initialise the system with the keyboard operation in order to reflect the new switch setting to your application. Refer to Part 6 OPERATION Section 6.8 System Initialisation for the keyboard operation.

4.6.1 No Printer, No External Drive

If you do not have a printer, external 5.25-inch floppy disk drive or PC Floppy Link, set the A-B-PRT switch to PRT and skip to the next step.

4.6.2 Printer, No External Drive

If you have a printer but no external 5.25-inch floppy disk drive or PC Floppy Link, make sure configuration switch 2 is down (off) and set the A-B-PRT switch to PRT. You'll never have to change it again.

4.6.3 External Drive, No Printer

If you have an external 5.25-inch floppy disk drive or the PC Floppy Link in your IBM compatible computer, the A-B-PRT switch should be set to either A or B depending on how you choose to identify the external drive.

When the A-B-PRT switch is set to A, the external drive is drive -A. When the switch is set to B, it is drive -B.

For most applications you want the A-B-PRT switch set to B. This way the internal disk drive is -A, the external drive is -B and the fixed disk is -C. The PART 5 Disks and Disk Drives explains more about drive identifiers.

4.6.4 Both a Printer and an External Drive

Before printing, set the A-B-PRT switch to PRT and connect the printer to the FDD/PRT port.

To use the external 5.25-inch floppy disk drive or PC Floppy Link, set the A-B-PRT switch to A or B and connect the drive's cable to the FDD/PRT port.

4.7 Setting DIP Switch

The ten configuration switches are numbered from left to right. The off position is down, the on position is up. Down is considered normal setting. The individual setting operates as follows.

Table 4-1 DIP Switch Setting

DIP Switch	Setting	Description
1	ON	Auto-Switched display mode
	OFF	IBM EGA full compatible ✓
2	ON	PRT port used both for input and output
	OFF	PRT port only for output ✓
3	ON	Communications port as CH2
	OFF	Communications port as CH1 ✓
4	ON	Double font in plasma for TEXT
	OFF	Single font in plasma for TEXT ✓
5	ON	Disable CRTC for EXT.CRTC
	OFF	Enable internal CRTC (normal) ✓
6	ON	North European Font to display
	OFF	Other Fonts (Normal) ✓
7 to 10	(Defined as follows)	

Table 4-1 DIP Switch Setting (continued)

Monitor in use	7	8	9	10
Standard RGB (40 column mode is default)	ON	OFF	OFF	ON
Standard RGB (80 column mode is default)	OFF	OFF	OFF	ON
Enhanced RGB (200 line or emulation of standard RGB is default)	ON	ON	ON	OFF
Enhanced RGB (350 line, true enhanced operation is default)	OFF	ON	ON	OFF

4.8 Colour CRT Display Connection

9-pin D-shell female connector is used to connect an RGB direct drive colour CRT display cable. Fasten it with screws as in Figure 4-7.

To use an external CRT Display, set the SW7 through SW10 according to Table 4-1 DIP Switch Setting.

Figure 4-7 CRT Display Connection

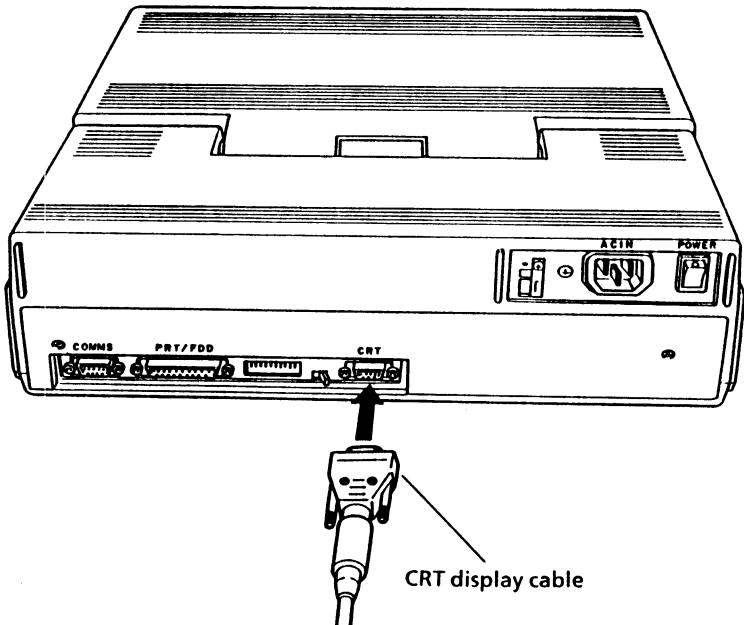

4.9 Printer Connection

If you have a printer with Centronics interface, follow the installation instruction described in the manual provided with the printer.

The PRT/FDD Connector (25-pin D-Shell connector) is used to connect one end of the printer cable and fasten the screws attached to the cable-side connector as in Figure 4-8 on the below.

Then set the A-B-PRT Switch properly in order to reflect the printer connection. For the setting, refer to Section 4.6 A-B-PRT Switch Setting.

Figure 4-8 Printer Connection

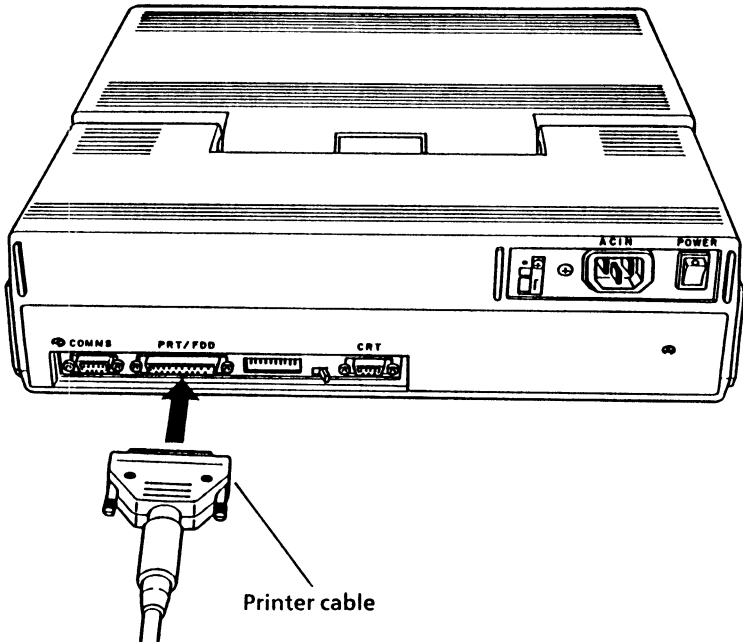

4.10 External Floppy Disk Drive Connection

If you have an external 5.25-inch floppy disk drive, follow the steps in the PART 5 Disks and Disk Drives.

PART 5 DISKS AND DISK DRIVE

This part introduces the T3200's storage devices. It begins with general concepts, describes how to use floppy disks and concludes with a discussion of how to install the external 5.25-inch floppy disk drive.

5.1	Concepts	1
5.2	Disk Drive Options	1
5.3	Disk Drive Identifiers	2
5.4	Saving Data on Disk	3
5.5	Write Protecting Disks	3
5.6	3.5-inch Floppy Disk	4
5.6.1	Floppy Disk Handling Precautions	5
5.6.2	Disk Write Protection	6
5.6.3	Labeling Disk	7
5.7	5.25-inch Floppy Disk Drive Unit	8
5.7.1	Parts	9
5.7.2	Connecting System Unit	10
5.7.3	Power ON and OFF	10
5.7.4	Floppy Disk	11
5.7.5	Disk Handling Precautions	12
5.7.6	Disk Write Protection	12
5.7.7	Labeling Disks	13
5.7.8	Disk Insertion	13
5.7.9	Disk Removal	14
5.7.10	Connecting AC Adaptor	14

5.1 Concepts

Two essential elements of any computer are its temporary and permanent storage devices. The computer's random access memory (RAM), commonly called memory, temporarily stores information during processing. Data in memory may disappear when you load a new program, and is lost when you turn the computer off. Disks provide more permanent memory.

The T3200 is equipped with two types of disk. The integrated hard disk drive which cannot be removed from the computer holds 40 megabytes of information.

The T3200 also includes a 3.5-inch floppy disk drive. You can remove floppy disk from their drive and store them or transport them to other computers.

5.2 Disk Drive Options

You can add an external 5.25-inch floppy disk drive to the T3200.

The T3200 also supports a 3 megabyte memory expansion option. Part of this memory can be set aside to function as a very fast disk drive. This is called a RAM, or virtual disk (VDISK).

5.3 Disk Drive Identifiers

Disk drives are identified by the letters -A, -B and -C, etc. The first fixed disk is always drive -C. The internal floppy disk drive on the right side of the computer is usually drive -A. If you have an external 5.25-inch floppy disk drive, MS-DOS identifies it as either drive -A or -B depending on how you set the A-B-PRT switch.

After a successful startup, the screen display the MS-DOS system prompt. The standard MS-DOS prompt indicates the current disk drive. For example:



```
C>_
```

is what the MS-DOS prompt looks like when you start the system from the hard disk.

If you issue a command without specifying a drive, MS-DOS assumes that you mean to use the current drive.

5.4 Saving Data on Disk

Data you type may not be stored automatically on the disk. For example, most word processing software maintains a copy of the document you are working on in the computer's memory. When you finish editing, it is your responsibility to save the document to disk.

How and when to save data depends on the type of software you are using. Save your work frequently. You can lose data unexpectedly, from a power failure or operating error. Make saving your data a reflex action as you work.

5.5 Write Protecting Disks

Microcomputers provide built-in safeguards to make sure you do not accidentally delete data. One of these safeguards is the mechanical ability to write-protected floppy disk. You cannot add, delete or modify files stored on a write-protected floppy disk. You can change information on unprotected floppy disk only.

5.6 3.5-inch Floppy Disk

Figure 5-1 shows the front and back of a 3.5-inch disk enclosed in its sturdy plastic jacket. During use, the disk spins inside the jacket. The metal protective covering moves aside and the disk drive's read/write head makes contact with the magnetic surface through the head window. There are several kinds of disks on the market, but the disks used in the internal FDD are the 3.5-inch double-sided, double-density, and double-track (2DD) type with recording capacity of 720 kilobytes.

Figure 5-1 3.5-inch Floppy Disk

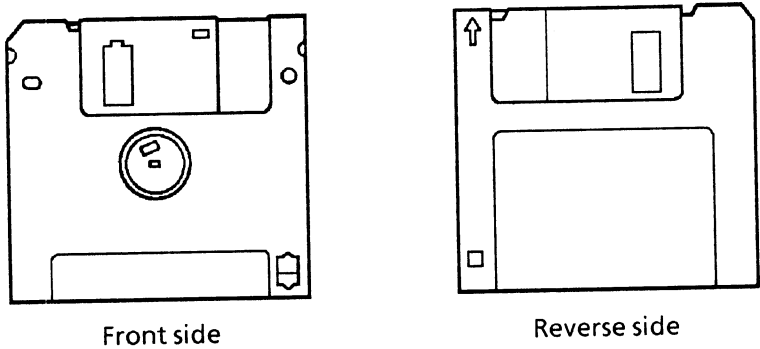

5.6.1 Floppy Disk Handling Precautions

Disks are very important to your system unit. Handle them with care. If one beeps damaged you could lose valuable information. A few precautions will increase the lifetime of your disks.

- o When not in use, store disks in the container they came in.
- o Do not touch or attempt to clean a disk inside a plastic jacket. Fingerprints or cleaning fluid may prevent an FDD from being properly read information on a disk.
- o Information on a disk may be damaged if the disk is twisted, bent, or dropped sharply, or if it is exposed to direct sunlight, extreme heat or cold, food, liquid or dust particles, including smoke.
- o Do not use a pencil or a ballpoint pen when you write on a label attached to a disk.
- o Do not use erasers on a label or near a disk.
- o Do not expose a disk to sources of magnetic energy. Keep it away from a loud-speaker in a radio or a television set.
- o Do not place a heavy objects on disks.
- o Do not use a rubber band or a paper clip on a disk.

5.6.2 Disk Write Protection

All your important disks should be protected from accidental erasure. Sliding the write protect tab on the disk to its outermost position makes the disk write protected. This prevent the disk from being erased or altered. Figure 5-2 shows the write protect tab.

Figure 5-2 The Write Protect Tab

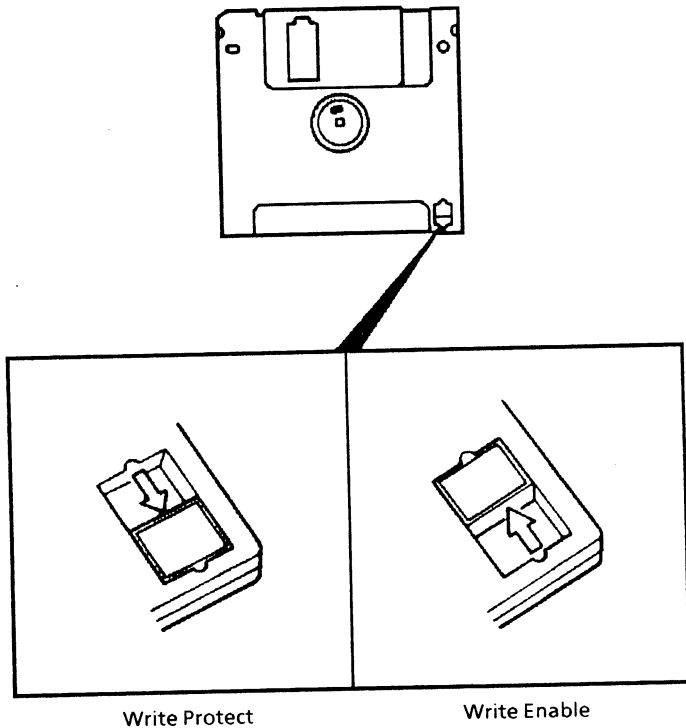

- o Write Protect : slide the tab toward the outermost position.
- o Write Enable : slide the tab toward the inner most position.

5.6.3 Labeling Disk

Each box of disks comes with press-on labels in multiple colours for your labeling convenience. Disks that contain programs or data should be labeling disks are:

- o Only use press-on labels designed for use on disks; most disk manufacturers include labels with the disks they sell.
- o If you need to write on a label after it has been put on a disk, use only a soft felt-tip pen. Writing with a ball point pen or pencil can damage a disk.

5.7 5.25-inch Floppy Disk Drive Unit

The T3200 can be connected to a 5.25-inch floppy disk drive unit as an optional external FDD unit. This option contains the following two items:

- 5.25-inch Disk Drive Unit
- Connector Cable

This drive unit uses a 5.25-inch Double-sided double-density (2D) disk.

Figure 5-3 5.25-inch FDD Unit

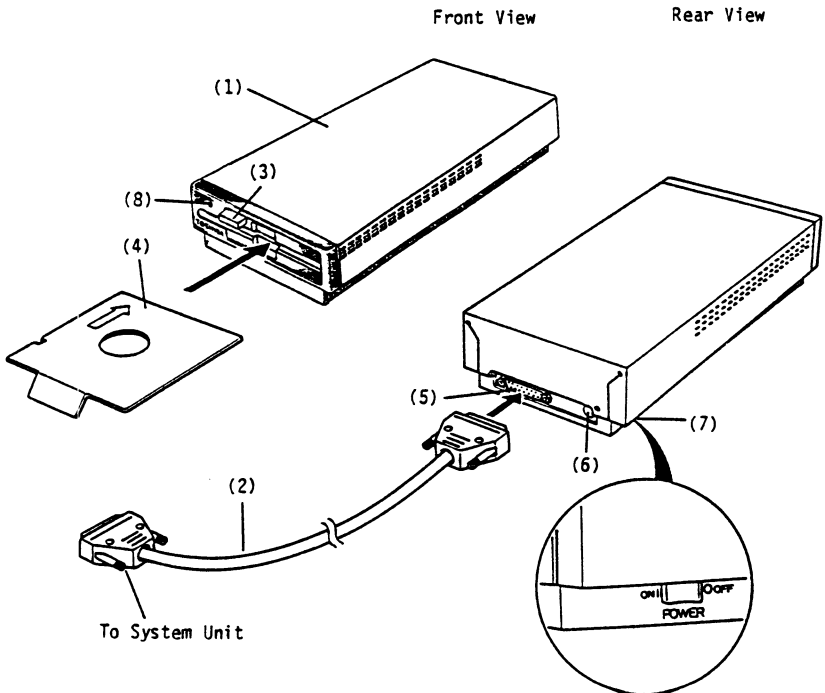

5.7.1 Parts

Refer to Figure 5-3 on the preceding page.

- (1) 5.25-inch Disk Drive Unit : This unit contains a 5.25-inch disk drive and a control circuit board.
- (2) Connector Cable : This cable connects the system unit to the drive unit.
- (3) Disk Clamp Lever : To remove a cardboard protector or disk, turn the clamp lever counterclockwise to open the floppy disk drive.
- (4) Cardboard Protector : This protects the magnetic head from vibration during shipment. Do not discard this protector and always insert it when this unit is being carried.
- (5) D-Shell Connector : Connect the 25-pin end of the connector cable here.
- (6) DC Jack : When operating the unit, connect the ac adaptor to this jack. DC output condition of the ac adaptor is as follows.

 DC output voltage : 18V
 DC output current : 600mA
- (7) Power ON/OFF Switch
- (8) "In Use" LED : This LED lights when the unit is in operation. Do not remove the disk while the LED is ON.

5.7.2 Connecting System Unit

Connect the drive to the system unit with the cable. The PRT/FDD connector (25-pin D-shell connector) is used to connect the disk cable.

5.7.3 Power ON and OFF

Turn the clamp lever and remove the cardboard protector first.

Power ON : Position the power switch to the rear (ON or 1).

Power OFF : Position the power switch to the front (OFF or 0).

Note that before switching off the power, check the unit is not in operation.

5.7.4 Floppy Disk

Figure 5-4 shows the front of 5.25-inch disk enclosed in its protective jacket. During use, the disk spins inside the jacket. The disk drive's read/write head contacts the magnetic surface of the disk through the head window.

Figure 5-4 5.25-inch Disk

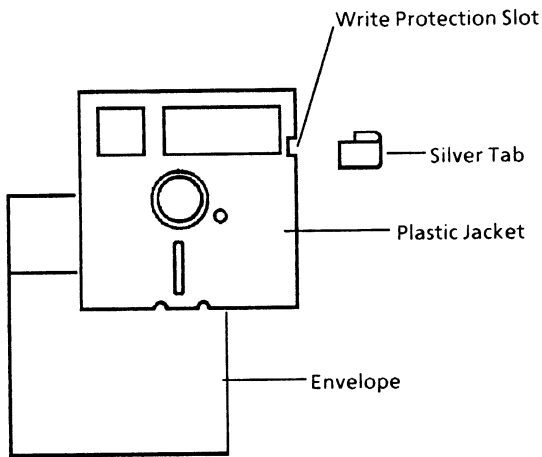

5.7.5 Disk Handling Precautions

See Section 5.6.1 Floppy Disk Handling Precautions.

5.7.6 Disk Write Protection

Figure 5-5 shows the write protection slot located in the upper right hand corner of the 5.25-inch disk. To write protect a 5.25-inch disk, cover the slot with a small silver tab. Most disk manufacturers include these tabs with each package of disks they sell. When the hole is covered, the system unit cannot alter the information on the disk. To remove write protection, carefully peel off the tab.

Figure 5-5 Disk Write Protection

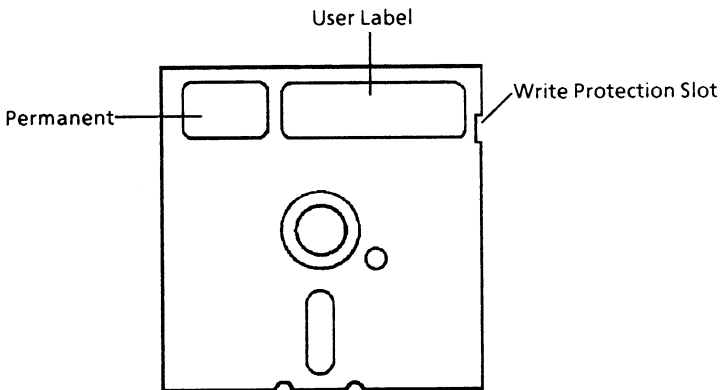

5.7.7 Labeling Disks

Most disk manufacturers provide press-on labels for your labeling convenience. Label disks that contain programs or data immediately. Points to keep in mind when labeling disks are:

- o Only use press-on labels designed for use on disks.
- o Write on the label first before applying it to the disk.
- o If you need to write on a label after it has been put on a disk, use only a soft felt-tip pen. Writing with a ball-point pen or pencil can damage a disk.

5.7.8 Disk Insertion

Slide a disk into the unit, making sure the label(s) on the disk jacket is faced up. An arrow may be marked on the disk jacket, this shows which end insert. Be sure to slide the disk all the way into the drive until the rear stop engages and turn the disk clamp lever clockwise to close the floppy disk drive.

5.7.9 Disk Removal

Follow these directions.

- (1) Check that the "in use" LED of the unit is OFF. Never remove a disk while the LED is on.
- (2) Turn the clamp lever counterclockwise.
- (3) Gently slide out the floppy disk.
- (4) Place disk in its envelope.

5.7.10 Connecting AC Adaptor

To operate the disk drive, power is supplied via the ac adaptor. Use the adaptor the correct specification.

Note that if the power does not come ON successfully, try the following procedure.

- (1) Switch ON with the ac adaptor connected.
- (2) Wait for about 20 seconds.
- (3) Switch OFF the power.
- (4) Then switch ON again.

PART 6 OPERATION

This part provides details on how to get started, introduces the keyboard, discusses backup procedures and serial configuration parameters, and concludes with simple maintenance you can do on your own.

6.1	Before You Begin	1
6.2	Turning Power ON	2
6.3	Power-on Self-test	3
6.4	Setup Execution	5
6.5	Loading MS-DOS	11
6.5.1	Loading MS-DOS from Floppy Disk Drive	11
6.5.2	Loading MS-DOS from Hard Disk Drive	13
6.6	Setting Up Gray Scale	14
6.7	Keyboard	15
6.7.1	Soft Switches	17
6.8	System Initialisation	18
6.9	Disk Removal from Drive	19
6.10	Turning Power OFF	20

6.1 Before You Begin

Make sure of the following.

- o The system is on a flat working surface at a comfortable height.
- o The voltage selection switch is set properly (115V or 230V depending on the voltage to the outlet you are using).
- o The ac power cable is firmly connected to the computer and to a wall outlet.
- o If present, the cardboard protector has been removed from external floppy disk drives.
- o The configuration switches reflect your actual setup.
- o Your hard disk has been formatted as a system disk and the MS-DOS command files copied to it.
- o You have several blank 3.5-inch disks.
- o Any external option, such as a disk drive or printer, is connected.

6.2 Turning Power ON

If you are using an external drive or printer, turn it on before turning on the computer.

Turn the system on by setting the on/off switch to the on position. The screen darkens for a few seconds then returns to normal.

To turn ON the system unit power, position the power switch at the rear of the system unit to ON.

Figure 6-1 Turning Power ON

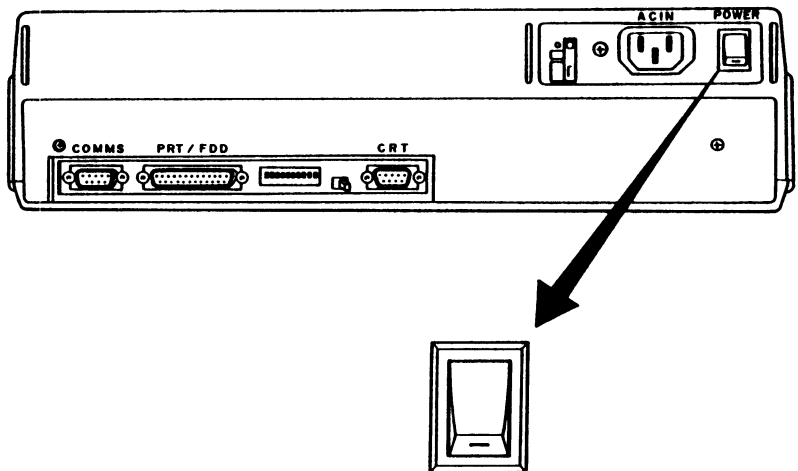

For an external 5.25-inch FDD, see PART 5 Disk and Disk Drives and for a CRT display or a printer, refer to the owner's manual attached to each of drives.

6.3 Power-on Self-test

A few seconds after turning the power ON, the T3200 automatically does a power-on self-test of its internal components.

MEMORY TEST XXXKB

The message remains on the screen for a few seconds as the memory in the computer is tested. This amount is usually 640 kilobytes but can be more if you have a memory extension option installed. Pressing any key stops the test execution.

When the diagnostics has been successfully completed, you get one short beep and the following messages on the display screen as a sign.

Insert system disk in drive
Press any key when ready....

When the partition of hard disk drive is not set, the following message appears.

*** HDD LOAD ERROR OR BAD SYSTEM DISK ***

If you do not get the above response, an error message such as

XXXX error

appears on the screen.
TROUBLESHOOTING.

Refer to PART 8

6.4 Setup Execution

The T3200 has battery backed-up memory in the system unit and keeps the system configuration descriptions in this memory. The power-on self-test compares the actual system configuration with the descriptions. If they are not the same, the test attempts to set up new system description with the following steps.

- (1) A message similar to the following may appear.

*** Error in CMOS. Bad Memory Size ***
Check system. Then, press [F1]key.....

If an error does occur, press **F1** key. The setup menu as in the following page appears on the screen.

[[System setup]]

- 1.Floppy disk drives = 1
 - Drive#1 type = 2 - 720KB/1.2MB
 - Drive#2 type = 0 - No drive

- 2.Hard disk drives = 1
 - Drive#1 type = 4 - Cyl=614,h=8,s/t=17

- 3.Memory size
 - System memory = 640KB
 - Extended memory = 0MB
 - Expanded memory = 384KB+ 0MB

- 4.External display card = None

Select setup change (1:No/2:Yes) ?

The descriptions in this menu show the system configuration stored in the battery backed-up memory.

Type **1** if the descriptions properly reflect the actual system configuration, or **2** if you want to change the descriptions. Typing **1** passes through the setup and restarts execution of the power-on self-test. Typing **2** forwards the setup operation to step (2).

(2) The message;

Select setup change (1:No/2:Yes) ?

appears on the screen bottom. Typing **1** writes new system descriptions into the battery backed-up memory, then returns the setup menu automatically. Confirm the new descriptions.

Typing **2** shows menus of descriptions in series as in step (3) and subsequent steps.

- (3) The following menu to set-up floppy disk appears on the screen.

[Floppy disk setup]

0: No drive
1: 360KB
2: 720KB/1.2MB

(1) Floppy disk drive#1 type = 2 ?

Type the corresponding number according to the message then press the **Enter** key. Note that the number 2 has to be set for the internal FDD unit.

Then the similar message as follows appears to set up the type of FDD number 2.

0: No drive
1: 360KB
2: 720KB/1.2MB

(2) Floppy disk drive#2 type = 0 ?

Type the corresponding number according to the message then press the **Enter** key.

- (4) The hard disk setup menu as follows appears.

[Hard disk setup]

(3) Is hard disk available ? (Y/N)

Type the corresponding character **y** or **n** then press the **Enter** key.

- (5) The next menu is to set-up the size of system working memory on the system board.

[Extended memory setup]

0: No memory
1: 0.5MB
2: 1MB
3: 1.5MB
4: 2MB
5: 2.5MB
6: 3MB

(4) Extended memory size = 00 ? [0MB]
(Expanded memory size [384KB+ 3MB])

This requests to set-up the expansion memory size. Choose the number reflecting the actual expansion memory size and type in the number. Then press the **Enter** key.

- (6) After display setup is complete, the screen returns to the system setup menu as in step (1). Confirm the descriptions and when the descriptions properly reflect the latest system configuration, type **n** to continue execution of the Power-on Self-test.

6.5 Loading MS-DOS

6.5.1 Loading MS-DOS from Floppy Disk Drive

Your system may need to load MS-DOS system from the floppy disk drive.

Insert the MS-DOS system disk into the FDD, properly as shown in Figure 6-2. If the disk is inserted with its top and bottom reversed, it will not enter correctly.

Figure 6-2 Inserting Disk into FDD

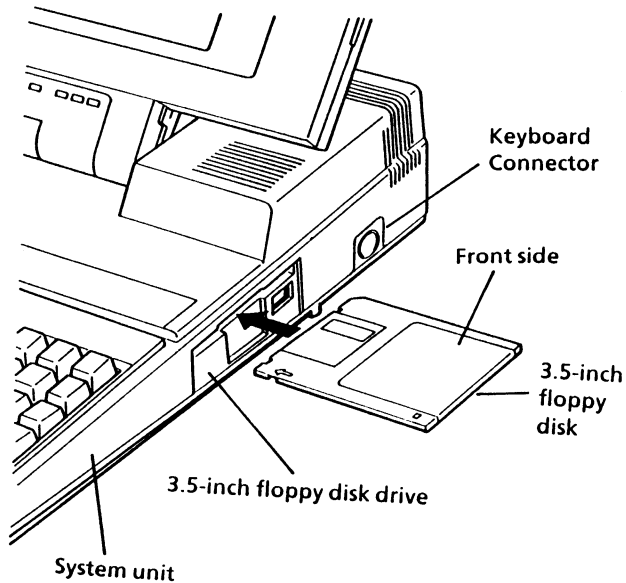

After inserting the disk, depress any key on the keyboard. MS-DOS is loaded. And the "Disk in Use" LED lights while MS-DOS is read from the disk. Note that you may insert the disk into the drive before the message

Insert system disk in drive
Press any key when ready....

appears. If you do so, the program loading starts automatically after completing the power-on self-test.

CAUTION

Never remove a disk when the "in use" light is ON. Otherwise the information in the disk might be damaged.

Additional information regarding further use of MS-DOS can be found in PART 7 USING MS-DOS.

6.5.2 Loading MS-DOS from Hard Disk Drive

If the MS-DOS system file has already been created on the hard disk drive, you can load the MS-DOS from the hard disk automatically. To do so, do not insert the MS-DOS floppy disk into a floppy disk drive.

While the MS-DOS is loaded the hard disk drive, the "Disk in Use" LED lights.

Additional information regarding further use of MS-DOS can be found in PART 7 USING MS-DOS.

6.6 Setting Up Gray Scale

How a colour is displayed on the plasma display is a user's option selectable through the program XCHAD (Enhanced CHAnge Display mode program). XCHAD is an external MS-DOS command. It allows you to change the gray scale according to the colours of display and change a video mode to another for T3200.

Step by step instructions on how to use the XCHAD command are given in PART 7 USING MS-DOS Section 7.3 Setting Up Gray Scale for Plasma Display.

6.7 Keyboard

It is divided into three sections; the typewriter key area, the function keys and the numeric keyboard.

For the UK (United Kingdom) version, the key cap layout appears as in Figure 6-3 on the following sheet.

T3200 provides several language versions of keyboard. See PART 9 OPTIONS for the keyboard versions and each keycap layout.

You can also use a keyboard of IBM PC/AT as an external keyboard through the keyboard connector.

Note that combinations of keys are occasionally referred to by key name and a plus (+) sign. For example, **Ctrl + Break** means you must hold down the **Ctrl** key and at the same time press the **Break** key.

Figure 6-3 UK Layout Keyboard

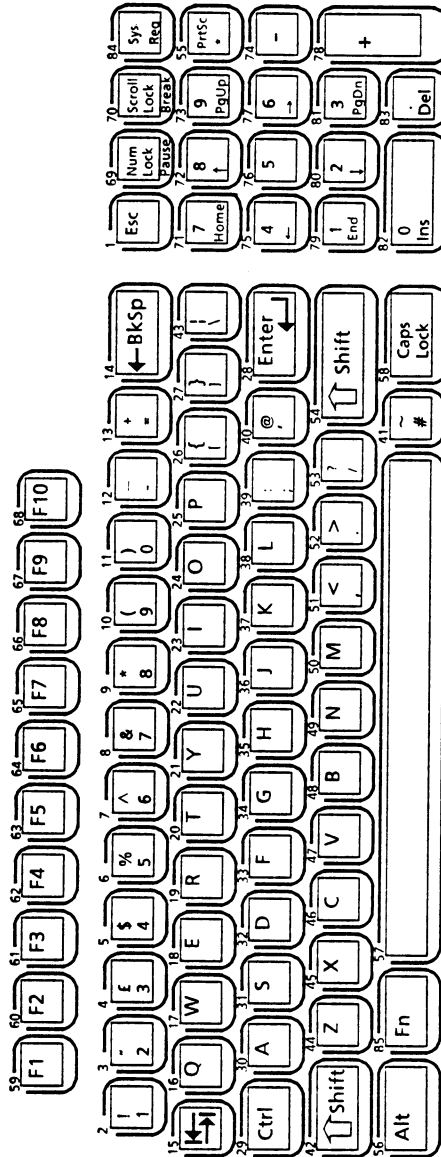

6.7.1 Soft Switches

Soft switches are key combinations that perform certain functions specific to the T3200. There are four soft switches use by the computer: two activate and deactivate the Plasma Display or CRT, one controls character display and one controls display area.

(1) Selecting the Display

If you attach an external monitor to the T3200, you need to use a soft switch to deactivate the Plasma Display and select the CRT.

Press : **Fn + End**

To return to the Plasma Display,

Press : **Fn + Home**

When you turn the T3200 off and back on again, the system selects the default display. (See Section 4.5 Setting Up Keyboard and Display)

(2) Selecting Character Display

On the T3200 characters can be displayed composed of a single row of dots or double row of dots. At computer start up, the screen shows normal characters composed of a double row of dots and intensified characters composed of a single row of dots.

To reverse the character display, press the soft switch **Fn + →**. This causes the screen to show normal characters composed of a double row of dots.

Press **Fn + →** to return to the first character display mode.

(3) Extending the Display Area

When the T3200 is in the mode that display on Plasma with pixels of 640 in columns and 350 in rows, you can extend the pixels to 640 in columns and 400 in rows.

To extend the pixels of 400 in rows,
Press : **Fn** + ↓

To return the pixels of 350 in rows,
Press : **Fn** + ↓

6.8 System Initialisation

The T3200 system initialisation is done at turning the system unit power ON, or by a keyboard operation.

You may need to initialise the system by a keyboard operation. For example, loading a new version MS-DOS without turning OFF the system unit power. In such a case, hold the **Ctrl** and **Alt** keys down and depress the **Del** key.

6.9 Disk Removal from Drive

You should remove a disk from the drive after you have finished using it. You may also remove any disks before turning OFF the system unit power.

- (1) Check that the corresponding "Disk in Use" LED is OFF. Never remove a disk while the LED is ON.
- (2) Push the Disk Eject Button, so that a disk pops out of the drive.
- (3) Gently slide out the disk.

6.10 Turning Power OFF

To turn OFF the system power, position the power switch at the rear of system unit to OFF.

Do not turn ON the power again immediately after turning it OFF. Wait a few seconds.

From the time you turn the power switch to OFF position you have approximately 5 seconds until power is not supplied to the system unit.

CAUTION

Do not turn OFF the system unit power while a "in use" or an "HDD" light is ON. Information in a floppy disk or hard disk, or the disk drive mechanism may be damaged.

Figure 6-4 Turning Power OFF

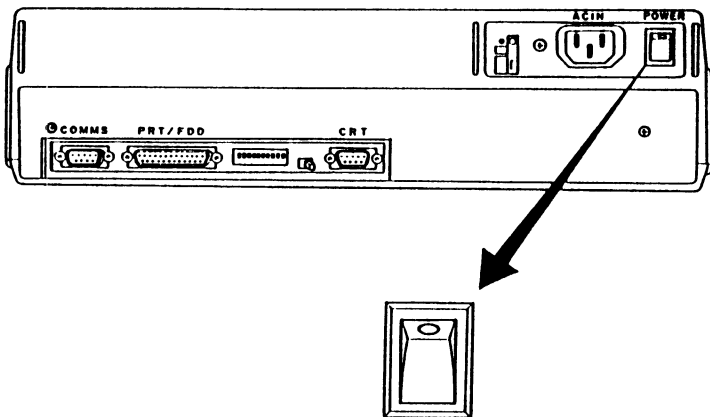

PART 7 USING MS-DOS

This part provides information on how to have access to MS-DOS. MS-DOS is a collection of programs on the MS-DOS system disk.

The procedures for gaining access to MS-DOS are discussed in the following order.

7.1	Starting MS-DOS	1
7.2	Entering Date and Time	3
7.2.1	Entering Date	3
7.2.2	Entering Time	5
7.3	Setting Up Gray Scale for Plasma Display	7
7.3.1	To Change Gray Scale	7
7.3.2	To Use XCHAD Menu	8
7.3.3	Command Mode	11
7.4	Changing Current Disk Drive	14
7.5	Using Keyboard	15
7.5.1	Data Keys	15
7.5.2	Correction of a Typing Mistake	17
7.5.3	Entering Command	17
7.5.4	Stopping Command Execution	18
7.5.5	Suspending Screen Output	18
7.5.6	Making Hard Copy of Screen Information	19
7.5.7	Restarting MS-DOS	19

7.6	Disk Files	20
7.6.1	Definition of File	20
7.6.2	File Names	21
7.6.3	Drive Designation	22
7.6.4	Global File Names	23
7.6.5	How MS-DOS Keeps Track of Your Files	24
7.7	Commands	25
7.7.1	Executing MS-DOS Commands	27
7.7.2	Internal and External Commands	28
7.7.3	DIR : Listing File Names	29
7.7.4	FORMAT : Initialising Disks	31
7.7.5	DISKCOPY : Making Backup Copies of Your Disks	36
7.7.6	COPY : Copying Files	40
7.7.6.1	Copying Files to Same Disk	40
7.7.6.2	Copying Files to Another Disk	42
7.7.7	RENAME : Changing File Name	44
7.7.8	TYPE : Displaying Contents of File	45
7.8	Device Error Message	46
7.9	Turning OFF System	48
7.10	Establishing National MS-DOS Disks	49
7.11	Using Hard Disk	52
7.11.1	Preparation	53

The detailed information on how to use MS-DOS programs is given in the MS-DOS Reference Manual.

7.1 Starting MS-DOS

There are two ways to start MS-DOS, depending on whether your T3200 is OFF or already running.

If the power to your T3200 is OFF:

Refer to PART 6 OPERATION. You can start MS-DOS by the following procedure.

- (1) Insert the MS-DOS system disk into drive -A.
- (2) Turn the system unit power ON.
- (3) Wait a moment while the T3200 checks itself out. The length of the pause depends on the amount of memory in your T3200. Then you will hear the disk drive clicking and see the "Disk in Use" LED come ON while MS-DOS is being read into memory.
- (4) The following message appears on the screen.

Toshiba Personal Computer...

- (5) After MS-DOS has been loaded, a startup message from MS-DOS appears on the screen.

If your T3200 is already running:

To start or restart MS-DOS, follow the procedure below.

- (1) Insert your MS-DOS system disk into the disk drive, if it is not inserted yet.
- (2) Hold both the **Ctrl** and **Alt** keys down and press the **Del** key. Then release all of them.
- (3) The startup message from MS-DOS appears on the screen.

Startup Message From MS-DOS

When MS-DOS is loaded and becomes ready to be operated, the following message (or a variation thereof) appears.

```
Toshiba Personal Computer MS-DOS Version 3.20/RXX
```

```
(C) Copyright Toshiba Corporation 1983,1987
```

```
(C) Copyright Microsoft Corporation 1981,1986
```

```
Current date is XXX X-XX-19XX
```

```
Enter new date (mm-dd-yy): _
```

The cursor indicates where the character you type will appear.

7.2 Entering Date and Time

The Real Time Clock (RTC) is built in the T3200. This unit works all the time and MS-DOS displays the date and time provided by the unit. Note that the RTC unit is backed up with an appropriate Ni-Cd battery.

7.2.1 Entering Date

When the message or prompt

Enter new date (mm-dd-yy): _

appears, you are expected to tell MS-DOS the current date. If the date having already been displayed is incorrect, type today's date as the form of mm-dd-yy, where;

- mm : is a one- or two-digit number from 1 to 12 representing month.
- dd : is a one- or two-digit number from 1 to 31 representing day of month.
- yy : is a two-digit number from 80 to 99 (the 19— is assumed), or a four-digit number from 1980 to 2099 representing year.

After you have typed in the date, press the **Enter** key to continue.

Separators : Separators between the numbers can be either hyphens (-) or slashes (/). For example,

6-1-87 or **6/1/87**

are both acceptable.

Invalid input : If you enter an invalid form of date, the T3200 re-prompts you with

Invalid date
Enter new date (mm-dd-yy):_

Format restriction : The format in which today's date is entered differs according to the national language version of MS-DOS.

Incorrect keying recovery : If you make a mistake while typing, use ← (backspace) key to remove one character for each keystroke. Then make your corrections. You may also press **Esc** key. This removes your current entry. You may then type a new entry for the prompt.

7.2.2 Entering Time

After you respond to the new date prompt and enter your answer by pressing the **Enter** key, you see a prompt similar to this.

```
Current time is X:XX:XX.XX
Enter new time: _
```

Enter the current time in the hh:mm or hh:mm:ss format, where,

hh : is a one- or two-digit number from 0 to 23 representing hours.

mm : is one- or two-digit number from 0 to 59 representing minutes.

ss : is one-or two-digit number from 0 to 59 representing seconds.

For example,

```
Current time is 0:00:14.32
Enter new time: 9:05
```

Separator : You have to use only the colon (:) to separate hours and minutes.

Invalid input : If you enter an invalid number or separator, MS-DOS repeats the prompt with the message

Invalid time
Enter new time: _

7.3 Setting Up Gray Scale for Plasma Display

XCHAD (Enhanced CHange Display) is an external command. It allows you to change the gray scale shown on the Plasma Display according to the colours.

Changes made to gray scale using XCHAD are not permanent unless you store them in the memory. The following instructions tell you how to change gray scale and how to make the changes permanent.

7.3.1 To Change Gray Scale

There are two ways to change the gray scale according to the colours on display and change a video mode to another for T3200: through the XCHAD menu and by using the XCHAD command.

Use the XCHAD menu to change the gray scale. Use the XCHAD command to enter the parameters if you do not permanently store the changes in memory. You can also use the XCHAD command to store them in memory to make the changes permanent.

7.3.2 To Use XCHAD Menu

Take the following steps to make screen.

- (1) Make sure that your MS-DOS system disk is in drive -A and prompt **A>** is displayed.
- (2) Type **xchad** and then press the **Enter** key.
- (3) You will see the following message on the screen.

```
A>xchad
  XCHAD installed
A>
```

- (4) Load your software into the system unit.

- (5) Press the **Ctrl** and the **Sys Req** key at once. The Window called XCHAD selection window appears on the right side of the Plasma Display.

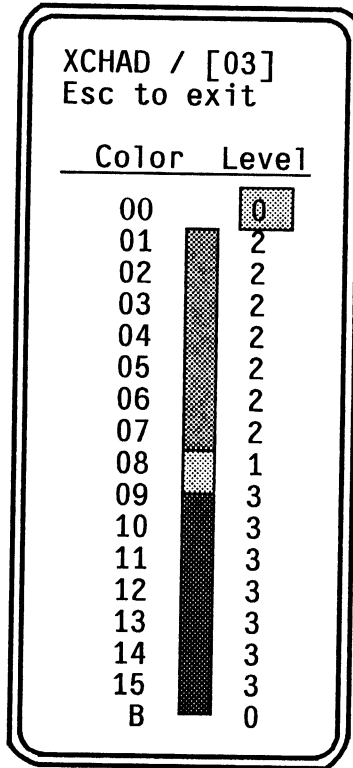

- (6) The reverse cursor indicates which colour entry number is currently specified and what level its gray scale is in. The gray scale, which is indicated as a bar between colour entry values and level entry values in CELT, shows each colour by the depth of a colour divided in 4 levels.

- (7) Use the up or the down arrow key to change the colour entry number and use the left or the right arrow key to change the level of the gray scale for the colour entry.
- (8) You can also move the XCHAD window. After pressing the **Scroll Lock** key one time to turn scroll lock on, you can move the window, by one character using the cursor keys or by five characters using both the **Shift** and the cursor keys. When you press **Scroll Lock** key once again to turn the scroll lock off, the window is anchored and you can change the level of the gray scale for colour entry.
- (9) Press **Esc** key to make the XCHAD special window disappear after you have defined the display modes.

All changes made in the special window are temporary ones. They will be lost if you turn your machine off or the system becomes down by accident before saving the changes.

7.3.3 Command Mode

You can use XCHAD immediately at the DOS prompt. The syntax of this command is:

XCHAD [[a0],---,[ai],---[a15],[ab]] [/Mn] [/Sn] [/L[n]]

The following section explains each option.

ai

Specifies the level of the gray scale for colour entry 'ai'. The range of colour entry 'i' is from 0 to 15 and b (border colour). The range of the level of gray scale 'ai' is from 0 to 3.

/Mn

Specifies screen mode 'n' to allow you to modify colour entry values of CELT. The range of screen mode 'n' is from 0 to 6, D, E, 10, 40 and 74. Default is the current screen mode.

/Sn

Specifies screen mode 'n' to allow you to switch the current screen. The range of screen mode 'n' is from 0 to 6, D, E, 10, 40 and 74. The /S option is incompatible with option /M and /L.

/L[n]

Specifies screen mode 'n' to allow you to get the contents of colour entry value in CELT. The range of screen mode 'n' is from 0 to 6, D, E, 10, 40 and 74. When 'n' is not specified, XCHAD tells you all of the colour entries for screen mode.

To take some examples of the XCHAD command with these options, the command

```
A>xchad 1,1
```

sets the level value of the gray scale for colour entry 0 and 1 to 1 each in the CELT for the current screen mode.

The command

```
A>xchad ,,3,,,,,,,,,,,,,1 /M06
```

sets the level value of the gray scale for colour entry 2 to 3 and that of the border colour to 1 in the CELT for screen mode 6. In this case, the current video mode does not change.

If the /S option is specified instead of /M after changing the colour entry values in the CELT for video mode 6 the same as the /M option, the command

```
A>xchad ,,3,,,,,,,,,,,,,1 /S06
```

sets the current screen mode to screen mode 6.

If you type

```
A>xchad /L10
```

This command displays the contents of CELT for screen mode as follows:

```
A>xchad /L10  
XCHAD 0,2,2,2,2,2,2,2,1,3,3,3,3,3,3,3,0 /M10
```

You can redirect the output from XCHAD to a Batch file. If you use XCHAD several times, the way to save the CELT in the Batch file using the /L option is efficient.

7.4 Changing Current Disk Drive

The system prompt tells you that MS-DOS is ready to accept a command. It also indicates which disk drive is current. For example:

```
A>_
```

indicates that drive -A is the current drive and MS-DOS is ready to accept a command.

To change the current drive, type the identifier letter of the drive you wish to make current (for example, C), followed by a colon (:). Then press **Enter** key. In our example, MS-DOS displays:

```
C>_
```

7.5 Using Keyboard

In many ways, the T3200 keyboard is similar to an ordinary typewriter keyboard. The T3200, however, has cursor keys and other special keys for computer functions. As you type, the cursor moves automatically to the next position.

For details on using the keyboard for MS-DOS, refer to the MS-DOS Reference Manual.

7.5.1 Data Keys

The keys contain upper and lower case letters, numerics and special symbols. These keys, along with the space bar, the **Shift** keys (there are two **Shift** keys) and the **Caps Lock** key, are operated as on a standard typewriter.

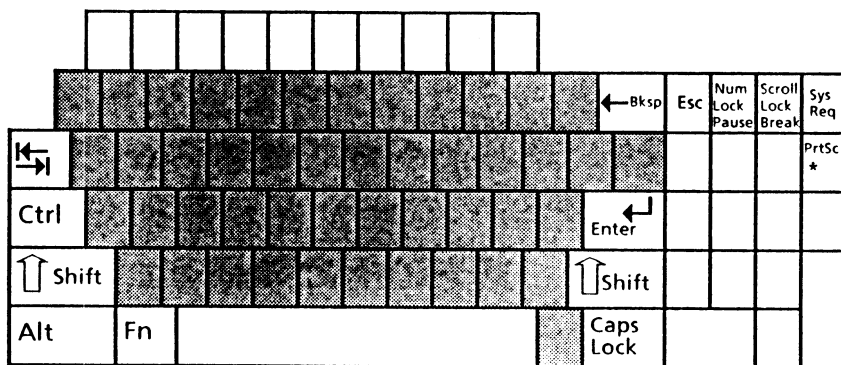

When the **Caps Lock** key is pressed, upper case characters can be entered without holding the **Shift** key. Pressing the **Caps Lock** key again returns to lower case mode. If you wish to retain the **Caps Lock** mode and type a few lower case, hold the **Shift** key down while typing.

7.5.2 Correction of Typing Mistakes

If you mistype any character on a line before pressing the **Enter** key, there are several ways to correct the mistake.



The backspace key moves the cursor to the left and removes one character for each keystroke. Make your corrections and then press the **Enter** key.



If you want to cancel all the characters typed on a line, press the **Esc** key. On the screen, a backslash (\) is displayed and the cursor moves down one line. Type the correct command and press the **Enter** key.

7.5.3 Entering Command

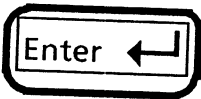

Press the **Enter** key when you have finished typing a whole command. This key is also called Return key.

7.5.4 Stopping a Command Execution

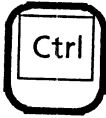

Holding the **Ctrl** key and pressing the **Scroll Lock** (or **Break**) key stops a command while it is executing its task. After the execution has been stopped, MS-DOS displays a prompt. You can then type your next command.

7.5.5 Suspending Screen Output

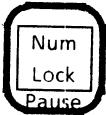
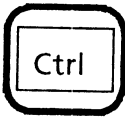

If information is appearing on the screen too fast for you to read, hold the **Ctrl** key down and press the **Num Lock** (or **Pause**) key. Then release both of them. This suspends the output of information to the screen. Press any key to continue the screen output.

7.5.6 Making Hard Copy of Screen Information

If your T3200 has a printer, first make sure that the printer power switch is turned ON.

Printing Current Screen : To print what is currently on the screen, hold the **Shift** key down, then press the **PrtSc** (Print Screen) key. Wait until the printer finishes printing.

Echoing : To print whatever is typed and displayed, hold the **Ctrl** key down and press the **PrtSc** key. After that, each time you press the **Enter** key or the computer displays a line, the line is printed on the printer. To cancel this "echoing" to the printer, hold the **Ctrl** key down and press the **PrtSc** key again.

7.5.7 Restarting MS-DOS

If you want to restart MS-DOS, insert MS-DOS system disk into drive -A. Then holding the **Ctrl** and the **Alt** keys down and press the **Del** key. Then release all of them.

7.6 Disk Files

7.6.1 Definition of File

A file is a collection of related information, which the system unit stores on a disk. A file can be compared to a file folder in a desk drawer. For example, one file folder may contain the names and addresses of employees who work in an office. You may name this file the Employee Master File. A file on your disk can also contain the names and addresses of employees in the office.

All data and programs on your disk reside in files and each file has a unique name. You refer to files by their names.

7.6.2 File Names

When you want to put data or a program into a file on your disk, you must give a name to the file. Some examples of file names are:

BUDGET
BUDGET.2Q
PROG1.TXT

A file's name takes either of the following forms.

ppppppppp or
ppppppppp.sss

ppppppppp represents the file name and .sss is a file name extension.

File names are 1 to 8 characters long. A file name extension starts with a period, has three characters or less, and follows immediately after the file name.

The characters in a file name can be alphanumeric, and symbols such as \$, #, &, @, !, %, (,), -, _, {, }, ', ^, and '.

MS-DOS treats all letters as capital letters. If a file name is followed by an extension, you must use both parts to specify that file.

7.6.3 Drive Designation

In addition to the file name and the file name extension, the name of your file may include a drive designation. The drive designation is a letter and a colon, such as A: or B:. This tells MS-DOS where the file is.

The file name and extension immediately follow the drive designation. For example,

A: BUDGET
B: PROGL.BAS

If you use a file name without the drive designation, as in

BUDGET

MS-DOS assumes that the file is located in the current (or default) disk drive.

7.6.4 Global File Names

Two symbols, the question mark (?) and asterisk (*) in a file name have special functions, to indicate a number of files with only one file name specification.

Suppose that your disk contains the files which have the following file names.

SALES.A1
SALES.B2
SALES.JAN

By typing **SALES.??** you can specify all of the files except the SALES.JAN. A question mark (?) represents any character which is located at that position.

An asterisk (*) represents any character or any number of characters which are located at that position. Thus if you type **SALES.*** you can specify all of the files shown above. Below are further examples.

- *.*** : All files on a disk.
- *.TTL** : All files on a disk with the extension "TTL".
- ???.A*** : All files which have a three-character file name and an extension beginning with "A".

7.6.5 How MS-DOS Keeps Track of Your Files

The names of your files are kept on the disk in an area known as the directory. The directory also contains information on the size of files, their location on the disk, and the dates and times they were created and updated.

Each disk can contain up to 64 or 112 files of varying sizes. The maximum number of files depends on disk format. If your files are large, the disk may be filled up with fewer than 64 or 112 files.

More information on files is found in the MS-DOS Reference Manual.

7.7 Commands

Commands are typed in response to an MS-DOS prompt such as **A>** or **B>** . By entering an MS-DOS command as a response to the prompt, you can ask MS-DOS to perform useful tasks.

Such MS-DOS commands function:

- o Compare, copy, display, delete, and rename files.
- o Copy and format disks.
- o Execute MS-DOS programs such as EDLIN, as well as your own programs.
- o Analyze and list directories.
- o Enter date, time, and remarks.
- o Set various printer and screen modes.
- o Copy MS-DOS system files to another disk.
- o Request MS-DOS to wait for a specific period of time.

Each of these commands is discussed in detail in the MS-DOS Reference Manual.

This section gives brief descriptions of the following commands.

- DIR** Displays a list of all the files with names on your disk.
- FORMAT** Prepares a disk for receiving information.
- DISKCOPY** Copies the contents of an entire disk to another disk.
- COPY** Copies specified file(s) to the same or other disks.
- RENAME** Changes the name of a specified file.
- TYPE** Displays the contents of a specified file.

7.7.1 Executing MS-DOS Commands

To execute an MS-DOS command on the T3200,

- (1) Make sure that MS-DOS has indicated it is ready to accept your commands by displaying a prompt such as **A>**
- (2) Type the command with any parameters the command requires. You can type in either capital or small letters.
- (3) Press the **Enter** key when your command is complete and typed correctly.

7.7.2 Internal and External Commands

Internal commands are resident in memory and can perform tasks without accessing the system disk. Some of the internal commands are:

COPY
DIR
RENAME
TYPE

You need not keep the MS-DOS system disk inserted in the drive when you use these commands.

External commands reside on the system disk. They must be read from the disk before they can execute. In other words, the system disk must be in a drive when you use an external command.

7.7.3 DIR : Listing File Names

You can look at a directory on any disk by issuing the DIR command to MS-DOS. This command tells MS-DOS to display all the file names in the directory.

- (1) Make sure that your MS-DOS system disk is in drive -A and prompt **A>** is displayed.
- (2) If your system has a printer, set the printer ready to print. On the keyboard, hold the **Ctrl** key down and press the **PrtSc** key.
- (3) Type **dir** and press the **Enter** key.



```
C>dir
```

- (4) MS-DOS displays and prints a directory listing of all the files in the directory of your MS-DOS system disk. The listing looks like this. (See the following page).

```
Volume in drive A is XXXXX
Directory of A:\
```

```
COMMAND  COM  16213  2-08-87  9:00a
ASSIGN    COM   904   2-08-87  9:00a
CHKDSK   COM  6468   2-08-87  9:00a
COMP     COM 13627   2-08-87  9:00a
DEBUG    COM 12146   2-08-87  9:00a
DISKCOPY COM  9037   2-08-87  9:00a
MORE     COM  8637   2-08-87  9:00a
```

```
      .
      .
      .
```

```
32 File(s) 497644 bytes free
```

Note that two MS-DOS system files, TBIOS.SYS and TDOS.SYS, are on your disk but they do not show up in a directory listing.

- (5) Hold the **Ctrl** key down and press the **PrtSc** key. This stops the "echoing" of information on the screen to the printer.

If you want to see the file names on a disk that contains your own files, insert your disk into drive -A at step (1).

7.7.4 FORMAT : Initialising Disks

When you get a new (or a blank) disk (diskette), the first thing you must do is to format (or initialise) it with the FORMAT command.

The FORMAT command prepares a blank disk for receiving information by performing the following steps.

- (1) Checking for defective spots on the disk.
- (2) Preparing the directory and "File Allocation Table" that eventually holds information about the files.
- (3) Writing the "boot record" at the beginning of disk.
- (4) Optionally copying the MS-DOS system files on the disk.

Normally you need not concern yourself about the above processes as MS-DOS takes care of these for you. You need to use the FORMAT command once for each new disk.

You might use the FORMAT command for the following purposes.

- o Analyzing the disk for defective spots and making sure these areas are not used for storing information.
- o Wiping out all files on a disk that you no longer need to use.

CAUTION

Formatting a disk destroys any data that exists on the disk.

The operation procedure to format a disk is as follows.

- (1) Make sure that your MS-DOS system disk is in drive -A and prompt **A>** is displayed.
- (2) Type **format /S** and then press the **Enter** key.

Note that the instructions given here assume that you format the new disk using the T3200 built-in FDD with drive -A to 720 kilobytes.

- (3) You will see the following message on the screen.

Insert new diskette for drive A:
and press ENTER key when ready_

- (4) Remove your MS-DOS system disk from the drive.
- (5) Insert the disk to be formatted into drive -A.
- (6) Press **Enter** key on the keyboard.

- (7) While FORMAT is formatting your disk, the following message is displayed.

```
Formatting 80 cylinders
9 sectors per track, 2 side(s)
Head:X Cylinder: XX
```

The "Disk in Use" LED for drive -A lights.

- (8) When formatting has finished, FORMAT issues a message similar to this.

```
Format complete
System transferred
```

- (9) You will then see something similar to this on the screen:

```
xxxxx bytes total disk space
xxxxx bytes used by system
xxxxx bytes available on disk
```

```
Format another (Y/N)?_
```

Type **n** to end the **FORMAT** command. Type **y** to format another blank disk. You do not have to press the **Enter** key.

If you press **n** , you see the MS-DOS prompt **A>** and you can remove your formatted disk.

- (10) In step (2) you type **format** without **/S** and press the **ENTER** key. Doing so does not copy the MS-DOS system files to your disk and the message **System transferred** does not appear on the screen. Normally you include **/S** when you are formatting disk that will contain program files (as opposed to data files).

7.7.5 DISKCOPY : Making Backup Copies of Your Disks

It is strongly recommended that you make copies of your disks and store the original disk in a safe place. If the disk becomes damaged or information stored on the disk is accidentally erased, you still have all the information on your original disk.

The DISKCOPY command duplicates the contents of a disk to another disk. You can use this command to copy both your MS-DOS system disk or a disk that contains your own files.

The instructions below assume that you make a copy of your disk by using the built-in disk drive.

You need two disks as follows.

- o **Source disk** is the original disk of which you will make a copy.
- o **Target disk** is one that will become the work disk.

When you use the DISKCOPY command, it is recommended that you set the write protection tab of the source disk to make sure that your source disk is not accidentally written on.

- (1) Make sure that your MS-DOS system disk is in drive -A and prompt **A>** is displayed.
- (2) Type **diskcopy** and press the **Enter** key.
- (3) You will see the following message on the screen.

Insert SOURCE diskette in drive A:
and press any key when ready

- (4) Remove the MS-DOS system disk from drive -A.
- (5) Insert your source disk into drive -A. Make sure that you have not inserted the target disk.
- (6) Press any key on the keyboard. The following message is displayed.

Copying 80 cylinders
9 sectors per track, 2 side(s)

- (7) You will then see the following message on the screen.

Insert TARGET diskette in drive A:
and press any key when ready

- (8) Insert the target disk.
- (9) Press any key.
- (10) If the target disk is not formatted or the format is different from the source disk, the following message is displayed.

Formatting while copying

- (11) Repeat steps (5) to (10) until the following message is displayed.

Copy another diskette (Y/N)?_

- (12) Remove the target disk.
- (13) Type **n** to end the DISKCOPY command. Type **y** to copy another disk.

CAUTION

Do not use the DISKCOPY command to duplicate the contents of a 3.5-inch disk formatted in 80 tracks per side to a 5.25-inch disk. The 5.25-inch disk does not have enough capacity to accept the contents of the 3.5-inch disk.

7.7.6 COPY : Copying Files

By using the COPY command, you can make a back-up copy of one file instead of the whole disk. You can copy a file to the same disk or to another disk.

7.7.6.1 Copying Files to Same Disk

- (1) Make sure that prompt **A>** is displayed. The COPY command is an internal command and you need not have the MS-DOS system disk in the drive.
- (2) Insert a disk containing the file to be copied into drive -A.
- (3) Lets assume that **DEMO** is the name of the file you want to copy, and that the copy is to have the file name **DEMO1**
Type **Copy demo demo1** and then press the **Enter** key. Note that you type the original file name first and the back-up file name second. Separate these file names with a space.

- (4) The "Disk in Use" LED for drive -A will begin to blink. When the copy has been completed, you will see the following message.

1 File(s) copied

- (5) You can check to see if the file **DEMO1** exists by typing **dir demo1** and pressing the **Enter** key.
- (6) Remove the disk from the drive -A.

Note that if the file **DEMO1** is already on the disk, the contents of **DEMO1** are replaced with the contents of **DEMO** . You can check to see if the name you have chosen already exists by typing **dir demo1** before step (3).

7.7.6.2 Copying Files to Another Disk

- (1) Make sure that prompt **A>** is displayed.
- (2) Insert the source disk that contains the original file, into drive -A.
- (3) Insert the target disk into drive -B.
- (4) Lets assume that **DEMO** is the name of the original file you want to copy.
Type **copy demo b:** and then press the **Enter** key.
- (5) The "Disk in Use" LED for each drive lights.
When the copy has been completed, you will see the following message.

1 File(s) copied

- (6) You can check to see if the target disk in drive -B now contains the file **DEMO** by entering the command **dir b:demo .**
- (7) Remove both disks from the drives.

Notes

1. If you want the copied file on the target disk to have a file name other than **DEMO** , specify the chosen file name immediately after **b:** . For example, **copy demo b:demo2 .**
2. If the target disk already contains the specified name, the contents of that file will be replaced with the contents of **DEMO**

7.7.7 RENAME : Changing a File Name

The RENAME command lets you change the name of a file.

- (1) Make sure that prompt **A>** is displayed.
- (2) Insert a disk into drive -A that contains the file name, e.g. **REPORT** which you want to change.
- (3) Lets assume that **REPORT** is to be changed to **DRAFT** Type **rename report draft** and then press the **Enter** key. Note that you have to type the old name first, and a space, then the new name.
- (4) You will see prompt **A>** and the file name which has been changed.

Notes

1. An attempt to change the name of a file to a name that already exists on the disk results in the following error message.

Duplicate file name or File not found

2. If the disk containing the file to be renamed is inserted into drive -B, type **rename b:report draft** .

7.7.8 TYPE : Displaying Contents of File

The TYPE command is used to display the contents of a file on the screen.

- (1) Make sure that prompt **A>** is displayed.
- (2) Insert a disk containing the file you want to display into drive -A.
- (3) If the file name is **SALES.DAT** , type **type sales.dat** and then press the **Enter** key.
- (4) The contents of the file is displayed on the screen. If the information appears on the screen too fast for you to read, hold the **Ctrl** key down and press **PrtSc** . This suspends the output of information to the screen. Press any key to resume the output.

Note that the contents of some files, such as program or data files written by the computer, are not always displayed in a readable manner. The information on the screen might look strange to you.

7.8 Device Error Messages

When you use a command which handles disks, such as DIR, FORMAT or PRINT, you might receive a device error message similar to the following.

```
<error type> error <I/O> <device>  
Abort, Retry, Ignore ?_
```

Where <error type> is one of the following:

Bad call format	Bad command
Bad unit	Data
Disk	No paper
Non-DOS disk	Not ready
Read fault	Sector not found
Seek	Write fault
Write protect	

<I/O> is either "reading" or "writing" and <device> is the device name in error.

The **Not ready** error message indicates that a disk is not properly inserted in a drive. Check to see if the disk has been correctly inserted into the drive, then type **r**

The **Write protect error** indicates that the write protection tab for a disk is set so that information stored on the disk cannot be written over. Make sure the disk is the one you want to use for writing information. If it is, reset the write protection tab, re-insert the disk into the drive, then type **r**. If it is not, type **a** and replace the disk, and restart.

Another error message related to a faulty disk is,



File allocation table bad, drive x

This error message means that possibly the disk was not formatted correctly before use.

7.9 Turning OFF System

To end your MS-DOS session, follow the steps below.

- (1) Make sure that the MS-DOS prompt, **A>** or **B>** is the last message displayed on the screen. If not, hold the **Ctrl** key down and press the **Scroll Lock** (or **Break**) key.
- (2) Remove your disks from the disk drives.
- (3) Turn your system OFF.

7.10 Establishing National MS-DOS Disks

MS-DOS system disks are prepared for each country. If you need to modify the set-up of the T3200 for an alternative, the following steps should be done.

You will need;

- o MS-DOS system disk (master)
 - o A new blank disk
-
- (1) Copy the MS-DOS system disk to a new blank disk using the DISKCOPY program.

 - (2) Remove the MS-DOS system disk from the drive and place the newly created disk, into drive -A.

- (3) You can then select the correct language and keyboard layout for the National MS-DOS system disk by using the SELECT program. Type **select** and press the **Enter** key. SELECT shows the following.

System Generation Program

<u>Country</u>	<u>Code</u>	<u>KB</u>	<u>Country</u>	<u>Code</u>	<u>KB</u>
United States	001	US	United Kingdom	044	UK
France	033	FR	Denmark	045	DN
Spain	034	SP	Sweden	046	SW
Italy	039	IT	Norway	047	NR
Switzerland	041	SL	Germany	049	GR

Select country code : 44

Select KB(keyboard) : UK

Create CONFIG.SYS in current drive A : (Y/N) ?

- (4) Choose country code (e.g., 001 for United States) from the menu on screen and press the **Enter** key. The following message appears.

Select KB(keyboard)

- (5) Choose keyboard code (e.g., US for United States) from the menu on the screen and press the **Enter** key. The following message appears.

Create CONFIG.SYS in current drive A: (Y/N) ?_

- (6) Type **y** or **Y** . You now have a national MS-DOS system disk that you can use for your everyday operation.
- (7) Hold the **Ctrl** and **Alt** keys down and press the **Del** key. Then release all of them. The new National MS-DOS will be then loaded.

7.11 Using Hard Disk

The T3200 can be equipped with a hard disk drive built in the left hand side of the system unit. Information can be stored on a hard disk in the same way as a floppy disk. However, the construction of the hard disk unit allows a greater storage capacity of information than a floppy disk.

You are able to allocate separate areas of the disk to different operating systems. You can have as many as four operating systems on the hard disk.

The area allocated to an operating system is called a partition. Each partition is set up using a hard disk setup program provided by the corresponding operating system. MS-DOS has the FDISK program for this purpose. If you plan to use MS-DOS only, you assign the entire disk space to the MS-DOS partition using the FDISK program.

7.11.1 Preparation

Just as you format a floppy disk for MS-DOS before using it, you must prepare a hard disk before you can store information on it. To prepare the hard disk, you

- o Set up MS-DOS partition on the hard disk with the FDISK program.

- o Format the disk partition with the FORMAT command and place MS-DOS on it. This enables you to boot the T3200 directly from the hard disk simply by turning the power ON.

- o Place your most used application programs or files on the disk from floppy disk(s).

Let us walk through steps for using the entire disk with MS-DOS.

- (1) Make sure that your MS-DOS floppy disk is in drive -A and prompt **A>** is displayed.
- (2) Type **FDISK** and press the **Enter** key.
- (3) You will see the following screen.

```
Fixed Disk Setup Program /Drive#1
Total 614 cylinders (136 sectors per cylinder)
No partitions defined      Size
Max. available space:    - 614 (40.7 MB)
Choose one of the following options : 1
    1: Create Partition
    2: Change Active Pertition
    3: Delete DOS partition
Press ESC to return to DOS/FDISK option
```

Type **1** and press the **Enter** key. Note that the option 1 is the default and is automatically selected if you do not type an option number before pressing the **Enter** key.

- (4) MS-DOS responds with the following.

Create DOS partition

Do you wish to use all space for the system
(Y/N)?_

Type **Y** . If you type **N** you can then specify the number of cylinders for the MS-DOS partition. Note that if your hard disk is already setup, FDISK displays the status of the existing partitions. Refer to the MS-DOS Reference Manual for further information.

- (5) In a few seconds, you see the following message;

Insert MS-DOS disk in drive A:
and press any key when ready

Ensure that the MS-DOS system disk is in drive -A and press any key. MS-DOS is reloaded into the T3200 memory. Now you are ready to format the disk partition.

- (6) Make sure that prompt **A>** is displayed. Then type **FORMAT C:/S** and press the **Enter** key. The **/S** option copies the MS-DOS system files and enables the hard disk to self-boot the system.
- (7) Then the following message appears.

Enter current Volume Label for drive C: _

- (8) Enter Volume Label then press **Enter** key. Or if you don't need Volume Label press only **Enter** key and a warning message as follows appears.

WARNING, ALL DATA ON NON-REMOVABLE DISK
DRIVE C: WILL BE LOST!
Proceed with Format (Y/N)? _

Press any key. A "Disk in Use" LED for the hard disk drive lights and the formatting status appears on the screen.

- (9) When the formatting has been completed, the following message will be displayed, as well as the disk space statistics.

Format complete
System transferred

The **FORMAT** then displays the disk space statistics and the DOS prompt **A>**

- (10) With your MS-DOS floppy disk in drive -A, type **COPY *.* C:** and then press the **Enter** key. This copies the rest of the MS-DOS files onto the hard disk. Your system could now be started directly from the fixed disk.
- (11) To boot MS-DOS from the hard disk, you would simply turn ON the power (or reset with **Ctrl** , **Alt** , and **Del** keys) with no disk in drive -A. Once you enter the date and time, prompt **C>** is displayed. You can now use any MS-DOS commands just as you would use with a floppy disk.

Note that whenever the T3200 is booted from the hard disk, MS-DOS displays prompt **C>** instead of **A>** . MS-DOS reserves the drive letter -C for the hard disk drive. Even if the T3200 has only one floppy disk drive, MS-DOS sets aside -A and -B for single-disk operation. Once you create the MS-DOS partition, you can not change its size without deleting and re-creating it.

- (12) The hard disk gives you the benefits of great storage capacity, reliability and faster data access. With these benefits, you may keep much of your most frequently used programs and data on the disk. This may create a risk of a different kind: serious disruption in the event of a possible, but unlikely, disk failure. To avoid the risk, you should implement a regular backup procedure. MS-DOS provides two commands for this purpose. The BACKUP command allows you to backup files or programs onto floppy disks. The RESTORE command restores these backup files from floppy disks onto the hard disk. However, you can only restore files that were previously backed up with the BACKUP command. Refer to the MS-DOS Reference Manual for further information about these commands.

PART 8 TROUBLESHOOTING

This part provides instructions on how to rectify an operational or system failure with the power-on self-test and/or the diagnostic test. This part contains the following four sections.

8.1	Directions	1
8.2	Before the Troubleshooting	2
8.3	Power-on Self-test	2
8.4	Diagnostic Test	10
8.4.1	Loading Diagnostic Test	10
8.4.2	Diagnostic Test	18

8.1 Directions

If a problem occurs:

- o **When starting the system** (after turning ON the power and loading an operating system such as MS-DOS) and before entering a command, follow the procedures in Section 8.3 Power-on Self-test.
- o **When entering a command**, e.g. when a new program is run, the problem that occurs here, it may not be due to the hardware. Therefore, find out if there is anything new in the way the computer is being used. Try to run another program. If one program runs and another does not, there is probably something wrong in the program, such as floppy disk format, the program itself, or specific operations in the program. If the problem persists, start at the troubleshooting Section 8.3 Power-on Self-test.
- o **When a program is running** and :

If something unexpected happens, run another program.

If one program runs and another does not, the program is probably faulty. If problems persist, follow Section 8.3 Power-on Self-test.

By using the Diagnostic Test, problems in the T3200 System Unit, Display, or Printer can be isolated.

8.2 Before the Troubleshooting

Set up the system to standard for checking.

- (1) Turn OFF the power switch of the system unit.
- (2) Disconnect all connectors except an ac power cord from rear panel.
- (3) Check that the A-B-PRT Switch on the rear side of the system unit is set to PRT side.
- (4) Confirm that a floppy disk is not inserted into an FDD. If a disk is inserted, remove the disk from the FDD.

8.3 Power-on Self-test

When the system power is turned ON, the system automatically checks to see whether the unit itself functions properly with the power-on self-test.

The test shows diagnostic messages on the display screen to help locate the source of any problem encountered.

- (1) Turn ON the system unit power.
- (2) Confirm that the Power LED is alight.

Figure 8-1 Power LED

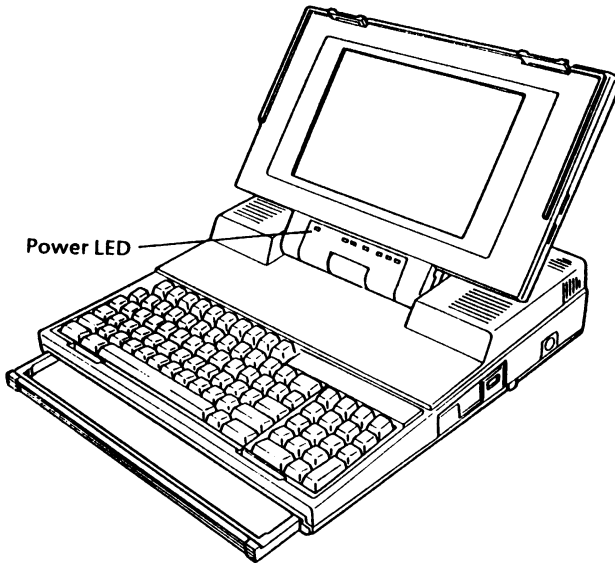

Is the Power LED alight ?

Yes : Go to step (3).

No : Check that the power cord is connected properly into the AC IN jack.
If the failure remains, the system unit is probably faulty, consult your dealer.

- (3) Turn OFF the power to the system unit.
- (4) Check that the ac select switch on the rear panel of the system unit properly reflects the ac power voltage.

Figure 8-2 Checking AC Select Switch

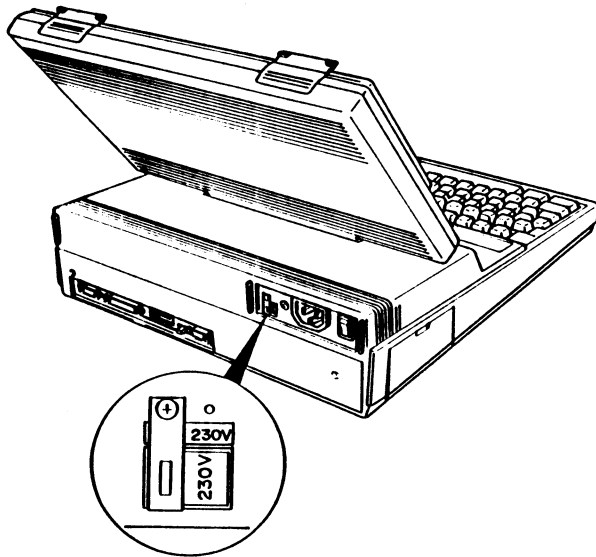

Is the switch set properly ?

Yes : Go to step (5) on the next page.

No : The power supply is damaged. So consult your dealer.

- (5) Confirm that all connectors and cables are inserted correctly and securely. The connectors are as follows.
- (a) AC Power Jack
 - (b) PRT/FDD Connector
 - (c) CRT Connector
 - (d) COMMS Connector

Figure 8-3 Cable Connectors

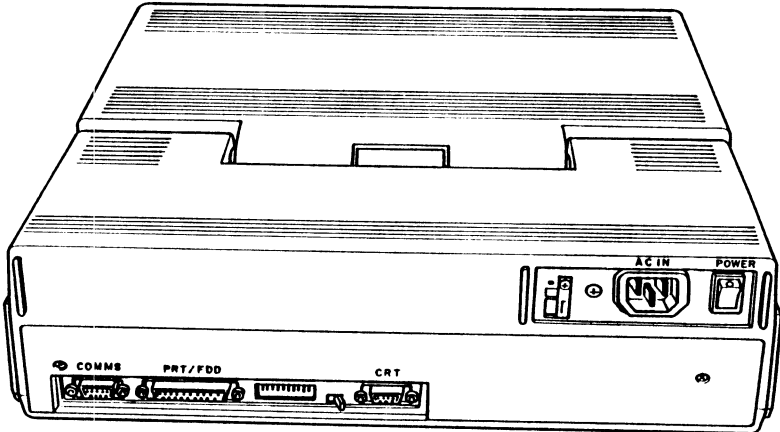

Are connectors and cables connected properly and securely ?

Yes : System unit is probably faulty, consult your dealer.

No : Correct them and return to step (1).

- (6) Confirm that the following message appears on the display screen.

MEMORY TEST XXXKB

Does the above message appear ?

Yes : Go to step (7) on the next page.

No : If you are using the Plasma Display, the system unit is probably faulty, consult your dealer.

If the symptom relates to a CRT display, turn OFF the system unit, then check for the following items.

- o Is the display power cord properly connected to a wall outlet ?
- o Is the display power on ?
- o Is the Brightness Control knob on the display turned up ?
- o Is the signal cable from the display properly plugged into the connector at the rear of the system unit ?

After checking the above items, turn ON the system unit power again. If the same symptom occurs, the system unit is probably faulty, consult your dealer.

- (7) Confirm that the following message is displayed on the screen.

Place system disk in drive.
Press any key when ready...

If the partition of hard disk drive is not set, the following message appears.

HDD LOAD ERROR OR BAD SYSTEM DISK

Is the above message displayed ?

Yes : Go to Section 8.4 Diagnostic Test.

No : Go to step (8) on the next page.

(8) You are here because the startup message is not displayed on the screen. Probable cause depends upon the symptom. Choose the appropriate one from the following four categories and take the appropriate action.

(a) If nothing appears on the screen following to the message **MEMORY TEST XXX KB**, the system unit is probably faulty, consult your dealer.

(b) If one of the error messages such as;

Failed PM (size proc)

KBC self test error

PE=1 (start)

appears on the screen, the system unit is probably faulty, consult your dealer.

- (c) If the message:

Error in CMOS, XXXX

appears on the screen, the actual system configuration differs from the one set up by the program System Setup, or the system may have a problem. Confirm the switches and device configuration of the system again.

- (d) If one beep sounds and the display looks incorrect or random characters appear on the screen, the system unit is probably faulty, consult your dealer.

8.4 Diagnostic Test

If the fault in the T3200 still can not be determined, use the diagnostic test.

The diagnostic test program is provided as a program on the MS-DOS system disk.

You need one work disk for diagnostic test.

8.4.1 Loading Diagnostic Test

- (1) Turn OFF the power switch of the system unit.
- (2) Insert the MS-DOS system disk into an internal FDD.
- (3) Turn ON the power switch of the system unit.
- (4) The power-on self-test starts. If you want to stop the test execution, press any key on the keyboard while the message **MEMORY TEST XXX KB** is on the display screen.

- (5) Confirm which of the following messages are displayed.

A

Insert system disk in drive
Press any key when ready....

B

Toshiba Personal Computer MS-DOS Version 3.20/RXX
(C) Copyright Toshiba Corporation 1983,1987
(C) Copyright Microsoft Corporation 1981,1986
Current date is XXX X-XX-19XX
Enter new date (mm-dd-yy): _

If the message A is displayed:

- o Confirm that the MS-DOS system disk has been correctly inserted into the disk drive.
- o Confirm that the A-B-PRT Switch at the rear of the system unit is set to the PRT side.

If this message is not displayed (the screen is blank), try another copy of the MS-DOS system disk. If the same symptom still persists, the system unit is probably faulty, consult your dealer.

If the message B is displayed, go to step (6).

(6) Depress the **Enter** key for the message

```
Current date is XXXXXXXX
Enter new date (mm-dd-yy):_
```

Consequently, the following message appears.

```
Current time is XXXXXXXX
Enter new time: _
```

By depressing the **Enter** key again, the prompt **A>** appears. This is an MS-DOS prompt which indicates that MS-DOS is waiting for instructions.

(7) Type **TEST3** then press the **Enter** key.

A>test3

TEST3 is the file name of the diagnostic test program. By typing this name the diagnostic test program is loaded, and the DIAGNOSTIC MENU appears on the screen. When the menu appears, go to step (7) on the next page.

If any problem occurs, try another copy of the MS-DOS system disk. If the same problem occurs, the system unit is probably faulty, so consult your dealer.

- (8) After loading diagnostic test successfully, the following DIAGNOSTICS MENU is displayed.

TOSHIBA personal computer T3200 DIAGNOSTICS
version X.XX(c) Copyright TOSHIBA corp 1987

DIAGNOSTICS MENU:

- 1 - DIAGNOSTIC TEST
- 8 - SYSTEM CONFIGURATION
- 9 - EXIT TO MS-DOS
- 0 - SETUP

PRESS [0]-[9] KEY

The DIAGNOSTIC TEST is designed to test basic components in the system unit, display and printer.

SYSTEM CONFIGURATION checks and displays the system configuration on screen.

EXIT TO MS-DOS returns to the MS-DOS prompt.

SETUP checks and displays the system setup on the screen.

When you see the above menu, go to step (9) for SYSTEM CONFIGURATION, step (9-1) for SETUP, step (10) for EXIT TO MS-DOS, and Section 8.4.2 for DIAGNOSTIC TEST.

If you do not get the above menu, the system unit is probably faulty, consult your dealer.

- (9) Type **8** and press the **Enter** key for SYSTEM CONFIGURATION. The screen displays the following message.

SYSTEM CONFIGURATION

- *- 640KB MEMORY
- *- PLASMA DISPLAY
- *- 1 FLOPPY DISK DRIVE(S)
- *- 1 ASYNC ADAPTER
- *- 1 HARD DISK DRIVE(S)
- *- 1 PRINTER ADAPTER
- *- 0 MATH CO-PROCESSOR
- *- 000KB EXPANSION MEMORY

PRESS [ENTER] KEY

To return to the DIAGNOSTICS MENU, press the **Enter** key.

- (9-1) Type **0** and press the **Enter** key for SETUP, the test displays the system setup description as follows.

[[System setup]]

```
1.Floppy disk drives = 1
   Drive#1 type      = 2 - 720KB/1.2MB
   Drive#2 type      = 0 - No drive

2.Hard disk drives  = 1
   Drive#1 type      = 4 - Cyl=614,h=8,s/t=17

3.Memory size
   System memory     = 640KB
   Extended memory   = 0MB
   Expanded memory   = 384KB+ 0MB

4.External display card = None
```

Select setup change (1:No/2:Yes) ?

Note that the above setup description is an example for a T3200 with one floppy disk drive and one hard disk drive.

- (10) To interrupt the diagnostic test, hold the **Ctrl** key down and depress the **Scroll Lock** (or **Break**) key. The screen will change to DIAGNOSTICS MENU.

Type **9** to select EXIT TO MS-DOS, then press the **Enter** key. The MS-DOS prompt will be displayed.

8.4.2 Diagnostic Test

The DIAGNOSTIC TEST contains the Running Test. The Running Test makes a sequential and continuous execution of the test programs as specified by the list of system parameters. In execution the Running Test, the test name and subtest number being currently executed are displayed.

The Running Test contains the System, Memory, Display, FDD (Floppy Disk Drive), HDD (Hard Disk Drive), Real Timer and Printer tests.

Running Test is executed in the following order.

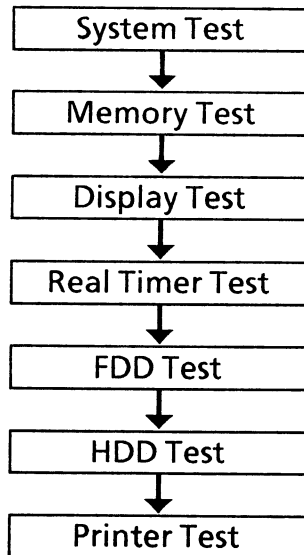

- (1) Type **1** to select the DIAGNOSTIC TEST from the DIAGNOSTICS MENU, then depress the **Enter** key. The following message appears.

Test the FDD (Y/N) ?

Typing **y** will execute the FDD test, **n** will skip the FDD test execution. Choose **y** or **n** then press the **Enter** key.

Test the HDD (Y/N) ?

Typing **y** will execute the HDD test, **n** will skip the HDD test execution. Choose **y** or **n** then depress the **Enter** key.

Test the printer (Y/N) ?

Typing **y** will execute the printer test, **n** will skip the printer test execution. Choose **y** or **n** then press the **Enter** key.

Note that if you enter **y** make sure the printer is properly connected to the system unit and check that the printer power is ON.

If you type **y** , the following message will appear.

Compatible with IBM printer (Y/N) ?

- (2) After pressing the **Enter** key in step (1), the screen changes to:

<test name> IN PROGRESS TSSDSS

In the TSSDSS part, the "T" indicates the test number, the first "SS" indicates the subtest number, the "D" indicates the drive (floppy disk or hard disk drive if being tested) and the last "SS" indicates hardware status.

Test No.1 (SYSTEM TEST) and No.2 (MEMORY TEST) will be executed.

If an error is detected, the test execution stops and the **ABORTED** message is displayed. If this happens,

- o Write down all messages displayed on screen.
- o Press any key on the keyboard to return to the DIAGNOSTICS MENU.
- o Turn OFF the power, and consult your dealer.

After a while, (when the execution of basic component subtests have been completed successfully) the DISPLAY TEST will be executed.

- (3) The constant data (FFFFH, AAAAH, 5555H, 0000H) and address data are written into the video RAM of 256 kilobytes and SRAM of 2 kilobytes and compare the data with the read data.

If an error is detected, the test execution stops and the **XXXXFF** message is displayed. If this happens,

- o Press the **Enter** key to return to the DIAGNOSTICS MENU.
- o Turn OFF the power, and consult your dealer.

Confirm the following items.

- o The line under the messages **NEXT LINE SHOWS ---** function properly as shown in the message.
- o When checking a colour CRT display, check the lines and colours function as described on the screen. There are three painted blocks in the screen. The left one shows background, the middle shows foreground, and the right shows intensified for each of colours specified beside the right block.

If all or one of them function incorrectly, consult your dealer.

If these functions are correct, press the **Enter** key to go to step (4).

- (5) After the **Enter** key is pressed in step (4), the screen changes to:

CHARACTER SET IN 40*25

Note that a full character set is displayed following the above message.

Check the screen. If any character is displayed out of its natural order, consult your dealer.

On the bottom of the screen, the message

PRESS [ENTER] KEY

appears. Press the **Enter** key to go to step (6).

- (6) After pressing the **Enter** key at the end of step (5), the screen changes to

80*25 CHARACTER DISPLAY

Note that a full character set is displayed following the above message. The top line shows each column number.

Check the screen. If any character is displayed out of its natural order, consult your dealer.

On the bottom of the screen, the message

PRESS [ENTER] KEY

appears. Press the **Enter** key to go to step (7).

- (7) When the Plasma Display is selected, the following screen appears after step (6).

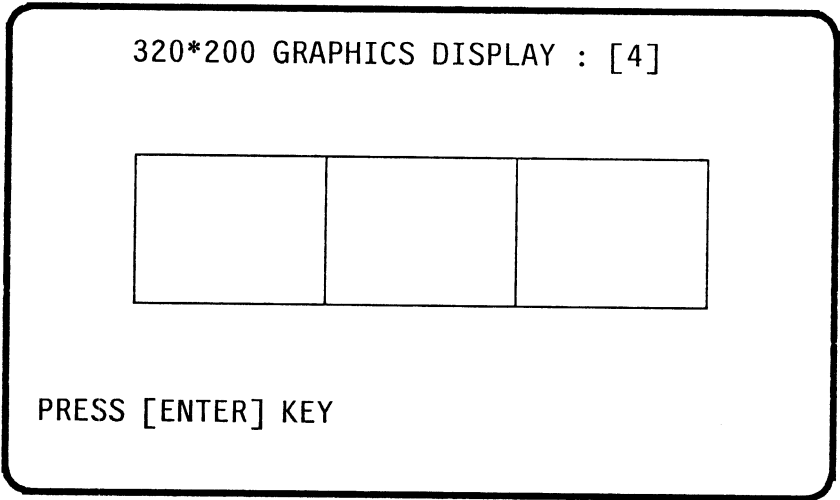

If any pattern is mismatched, consult your dealer.

Press the **Enter** key to go to step (8).

When a CRT display is selected, the following screen appears after step (6).

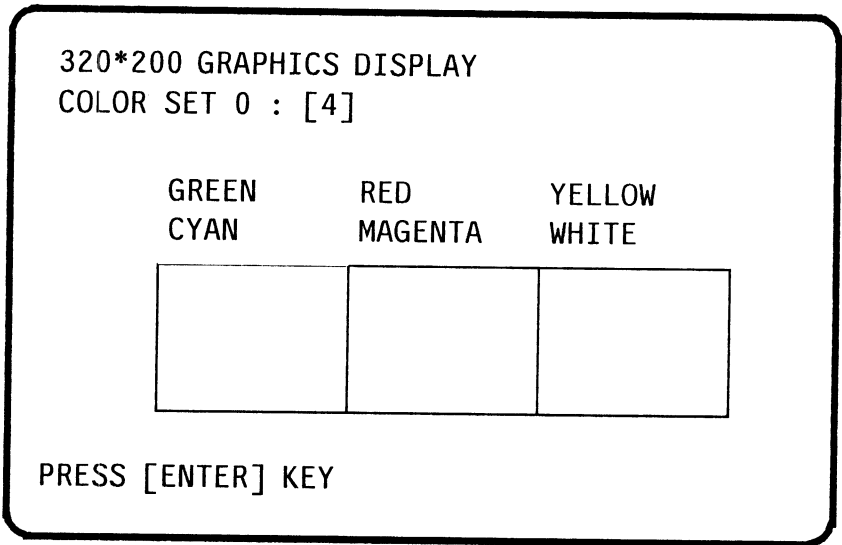

Note that YELLOW may look similar to brown.

If any part of the screen is incorrect, consult your dealer.

The screen displaying colour set zero (0) (GREEN, RED, YELLOW) as shown in the above example automatically changes to display colour set one (1) (CYAN, MAGENTA, WHITE) after a few seconds.

Press the **Enter** key to go to step (8).

- (8) When the Plasma Display is selected, the following screen appears after step (7).

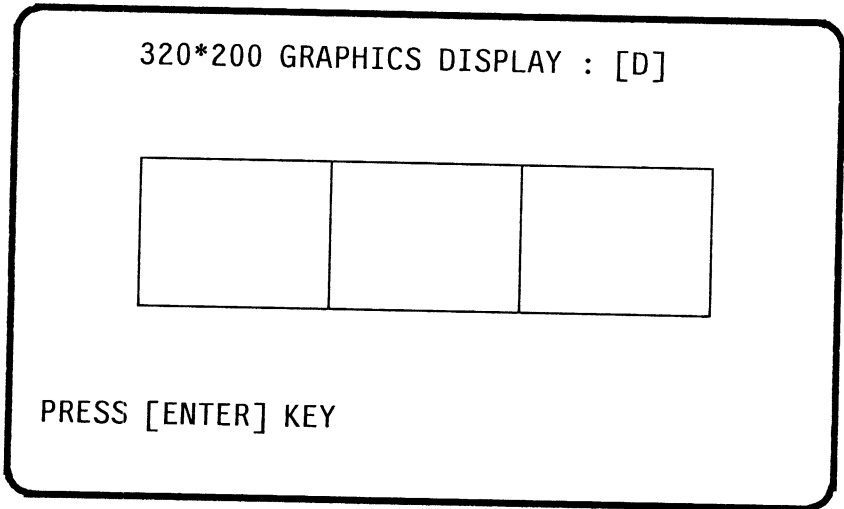

If any pattern is mismatched, consult your dealer.

Press the **Enter** key to go to step (9).

When a CRT display is selected, the following screen appears after step (7).

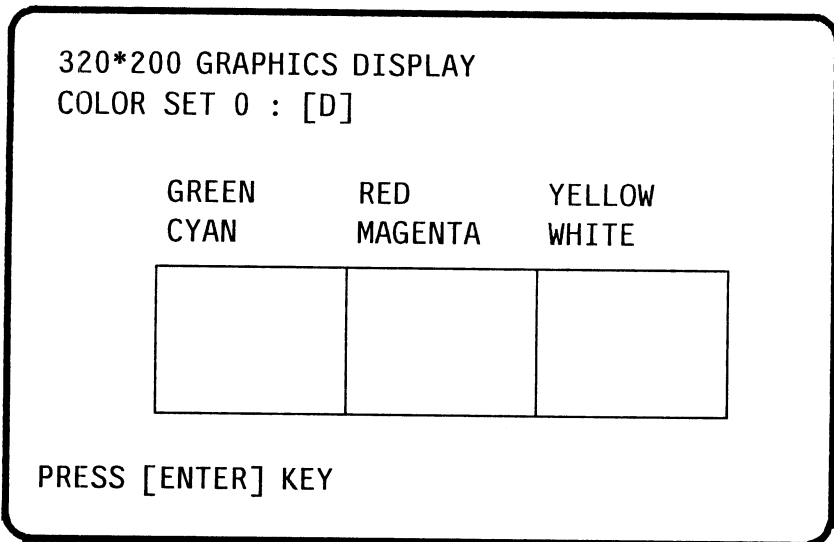

Note that YELLOW may look similar to brown.

If any part of the screen is incorrect, consult your dealer.

The screen displaying colour set zero (0) (GREEN, RED, YELLOW) as shown in the above example automatically changes to display colour set one (1) (CYAN, MAGENTA, WHITE) after a few seconds.

Press the **Enter** key to go to step (9).

- (9) When the Plasma Display is selected, the following screen appears after step (8).

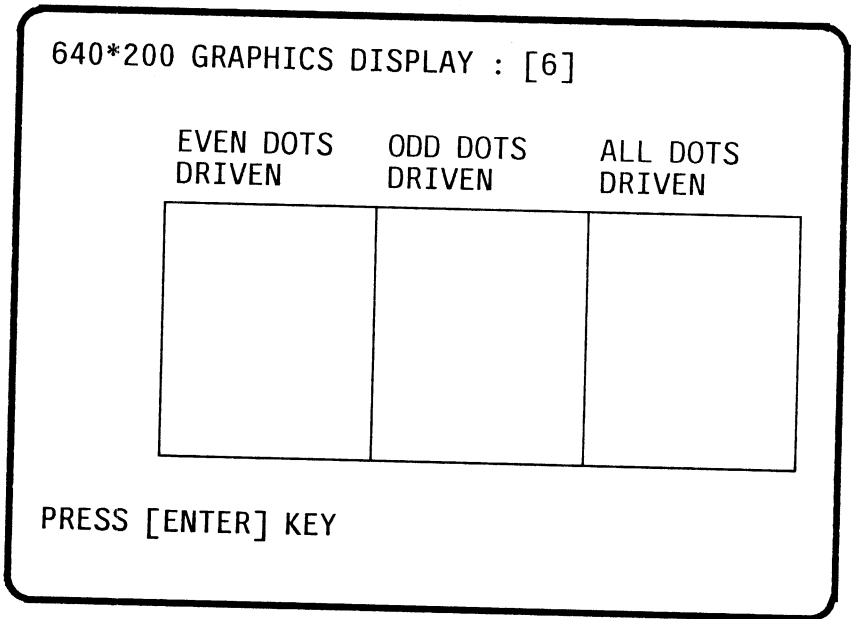

If any pattern is mismatched, consult your dealer.

Press the **Enter** key to go to step (10).

When a CRT display is selected, the following screen appears after step (8).

640*200 GRAPHICS DISPLAY : [6]

EVEN DOTS DRIVEN	ODD DOTS DRIVEN	ALL DOTS DRIVEN

PRESS [ENTER] KEY

If any part of the screen is incorrect, consult your dealer.

Press the **Enter** key to go to step (10).

- (10) If Plasma Display is selected, the following screen appears after step (9).

640*200 GRAPHICS DISPLAY : [E]

EVEN DOTS DRIVEN	ODD DOTS DRIVEN	ALL DOTS DRIVEN

PRESS [ENTER] KEY

If any pattern is mismatched, consult your dealer.

Press the **Enter** key and go to step (11).

When a CRT display is selected, the following screen appears after step (9).

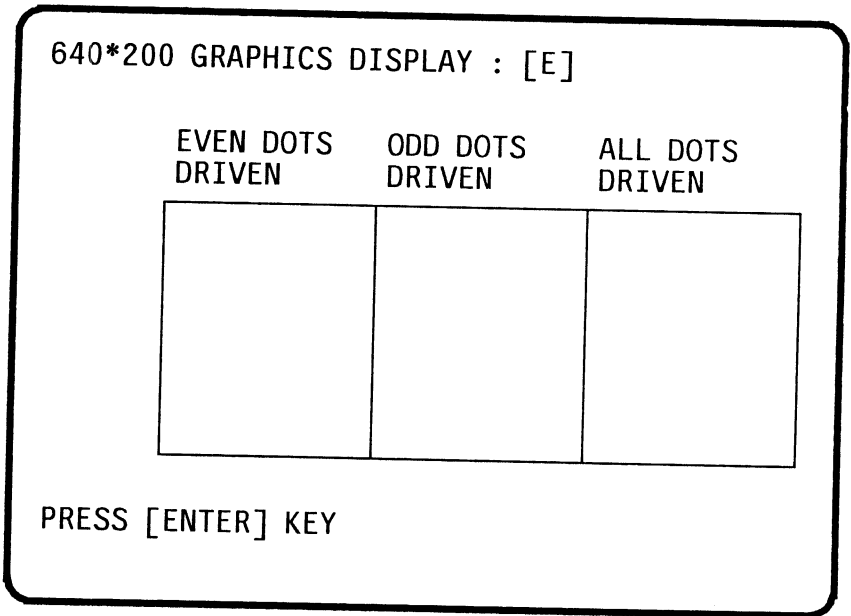

If any part of the screen is incorrect, consult your dealer.

Press the **Enter** key to go to step (11).

- (11) If Plasma Display or IBM Enhanced Graphics Adaptor is selected, the following screen appears after step (10).

640*350 GRAPHICS DISPLAY : [10]

EVEN DOTS DRIVEN	ODD DOTS DRIVEN	ALL DOTS DRIVEN

PRESS [ENTER] KEY

If any pattern is mismatched, consult your dealer.

Press the **Enter** key and go to step (12).

- (12) If Plasma Display is selected, the following screen appears after step (11).

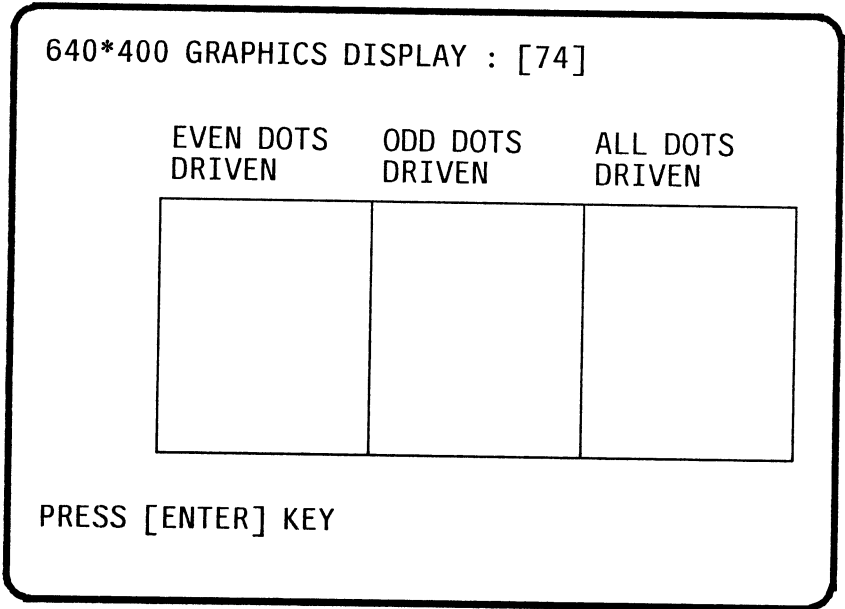

If any pattern is mismatched, consult your dealer.

Press the **Enter** key and go to step (13).

- (13) After pressing the **Enter** key at the end of step (12), the screen changes to:

FLOPPY DISK XXXXX

Mount work disk(s) on drive(s),
then press [ENTER] key.

[Warning : The contents of disk(s)
will be destroyed]

Insert a blank work disk into the internal disk drive. To test an external disk drive (5.25-inch disk drive) besides the internal disk drive(s), insert another blank work disk into that disk drive and make sure that the power for the drive is turned ON.

Ensure that these work disks are formatted.
See PART 7 USING MS-DOS for formatting disks.

If the drive(s) are ready to be tested, press the **Enter** key. The message **IN PROGRESS** will appear and the FLOPPY DISK tests begin.

If an error occurs during test execution, the message **ABORTED** is displayed. Write down all messages and press **Enter** key to return to the DIAGNOSTICS MENU. Then check the following items.

- o Are the work disk(s) properly formatted ?
- o Repeat the DIAGNOSTIC TEST with another work disk(s). If the message **ABORTED** appears again, consult your dealer.

When the test execution has been completed successfully, go to step (14).

- (14) Test No.8 (HARD DISK TEST) will be executed automatically after the step (13). The following message appears on the screen.

HARD DISK IN PROGRESS XXXXX

If an error occurs during the test execution, the message **ABORTED** is displayed. Write down all messages and depress any key to return to the DIAGNOSTIC MENU.

When the test execution has been completed successfully, the screen changes to the DIAGNOSTIC MENU with no action taken if the printer test is not directed in step (1).

If the test execution has been completed successfully, go to step (15).

- (15) If the printer test is specified in step (1), the following message appears on the screen.

PRINTER TEST IN PROGRESS XXXXX

The printer will print the following image.

PRINTER TEST

1. THIS LINES SHOWS NORMAL PRINT.
 2. THIS LINE SHOWS DOUBLE WIDTH PRINT.
 3. THIS LINE SHOWS COMPRESSED PRINT.
 4. THIS LINE SHOWS EMPASIZED PRINT.
 5. THIS LINE SHOWS DOUBLE STRIKE PRINT.
- ALL CHARACTERS PRINT

!"#\$%&'()*+,-./0123456789:;<=>?@ABCDEFGHIJKLMNORSTUVWXYZ[\]^_`abcdefghijklmnopqrstu

If a problem occurs, the message **ABORTED** appears on the display screen. Check the following items.

- (1) Is the printer ready to print ?
 - o Is there ac power from the wall outlet ?
 - o Is the printer power cord properly plugged into the wall outlet ?
 - o Is the printer power switch turned ON ?
 - o Is the printer signal cable properly connected to the printer and the system unit ?
 - o Are the ribbon, forms, tractor, and printer control switches set properly ? (Refer to the printer's "Owners Manual" for instructions on troubleshooting of the printer.)

- (2) Disconnect the printer cable from the printer port located at the rear of the system unit, and repeat the test.

Did the **ABORTED** message appear on the screen again ? If so, have the printer and/or the printer cable serviced. If not, consult your dealer.

When test has been completed successfully, the screen changes to the DIAGNOSTICS MENU.

PART 9 OPTIONS

The T3200 has several options for extending its functions.

9.1	General	1
9.2	System Kit	2
9.3	Keyboard	3
9.4	Memory Expansion Option	11
9.5	PC Floppy Link	11

9.1 General

The T3200 options expand the computer's capabilities. This part discusses each option.

The options are as follows.

- o External 5.25-inch floppy disk drive
- o External RGB colour monitor
- o Memory Expansion Option
- o PC Floppy Link

The external 5.25-inch floppy disk drive is discussed in the PART 5 DISK AND DISK DRIVES. The RGB colour monitor installation is described in PART 4 SETTING-UP.

9.2 System Kit

The T3200 provides system disks which correspond to the seven language versions. The versions provided are UK (United Kingdom), USA (United States), Germany, France, Spain, Scandinavia, Italy and Switzerland. The order number of each system kit versions is as follows.

SYSTEM KIT VERSION	ORDER NUMBER
USA	PA7866US
UK	PA7866EN
German	PA7866GR
France	PA7866FR
Spain	PA7866SP
Italy	PA7866IT
Scandinavia	PA7866SC

Each of these system kits is a 3.5-inch floppy disk which stores MS-DOS and diagnostics programs.

To use the system disk, see PART 6 OPERATION, PART 7 USING MS-DOS, and PART 8 TROUBLESHOOTING.

9.3 Keyboard

A keyboard is provided for each of the seven countries supported. The versions of keyboard are in the table below. Figure 9-1 through Figure 9-7 on the following pages show the key layouts.

KEYBOARD VERSION	ORDER NUMBER
USA	PA7091US
German	PA7091GR
France	PA7091FR
Spain	PA7091SP
Italy	PA7091IT
Scandinavia	PA7091SC
Switzerland	PA7091SL

Figure 9-1 USA Keyboard

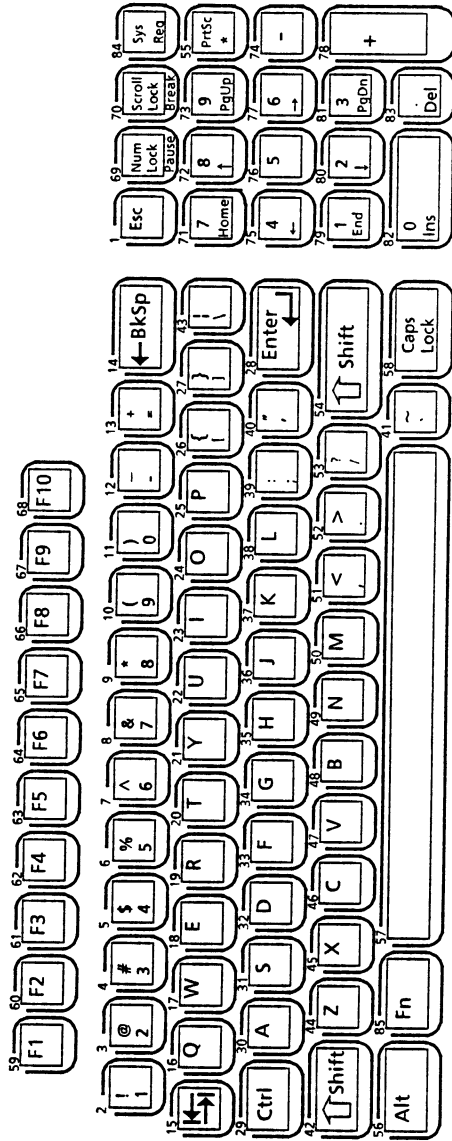

Figure 9-2 German Keyboard

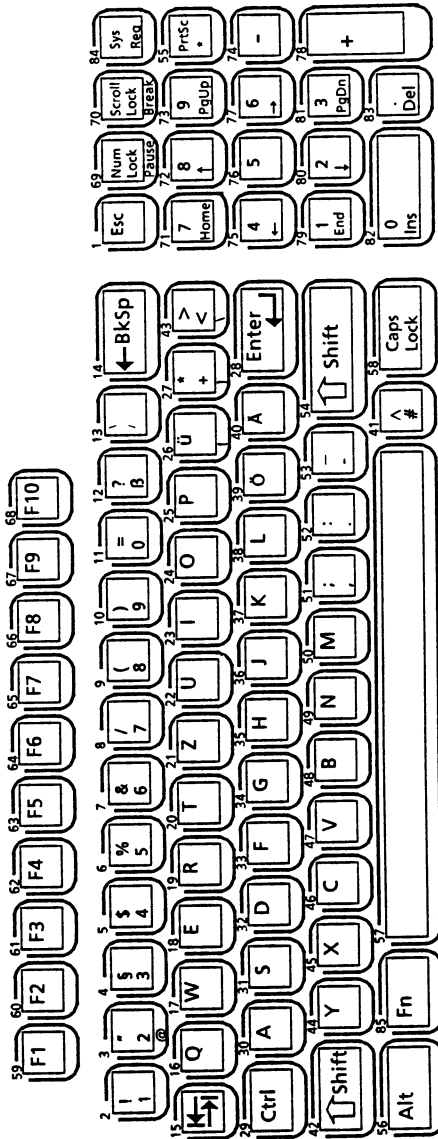

Figure 9-3 French Keyboard

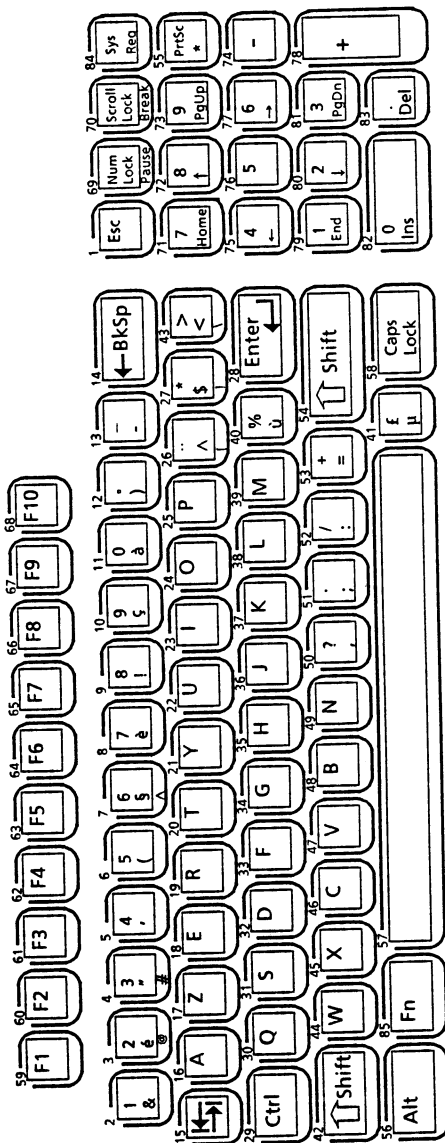

Figure 9-4 Spanish Keyboard

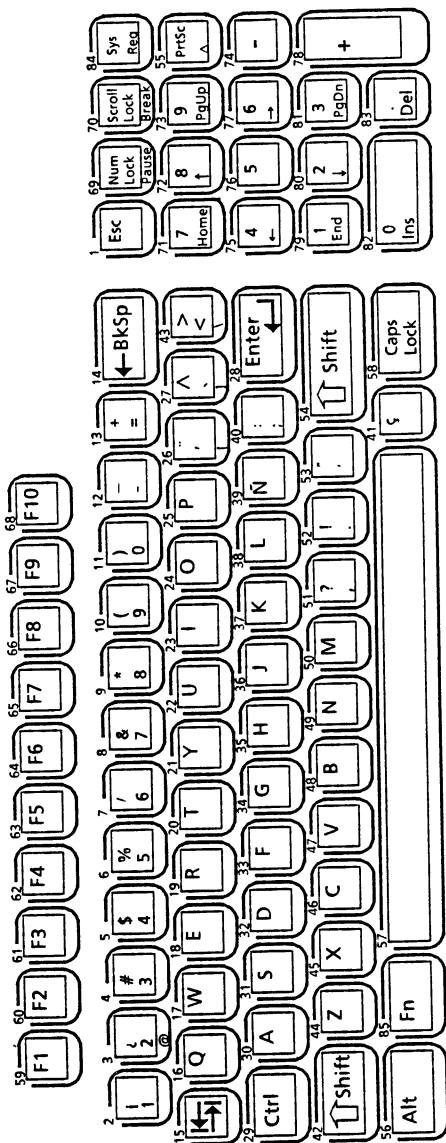

Figure 9-5 Scandinavian Keyboard

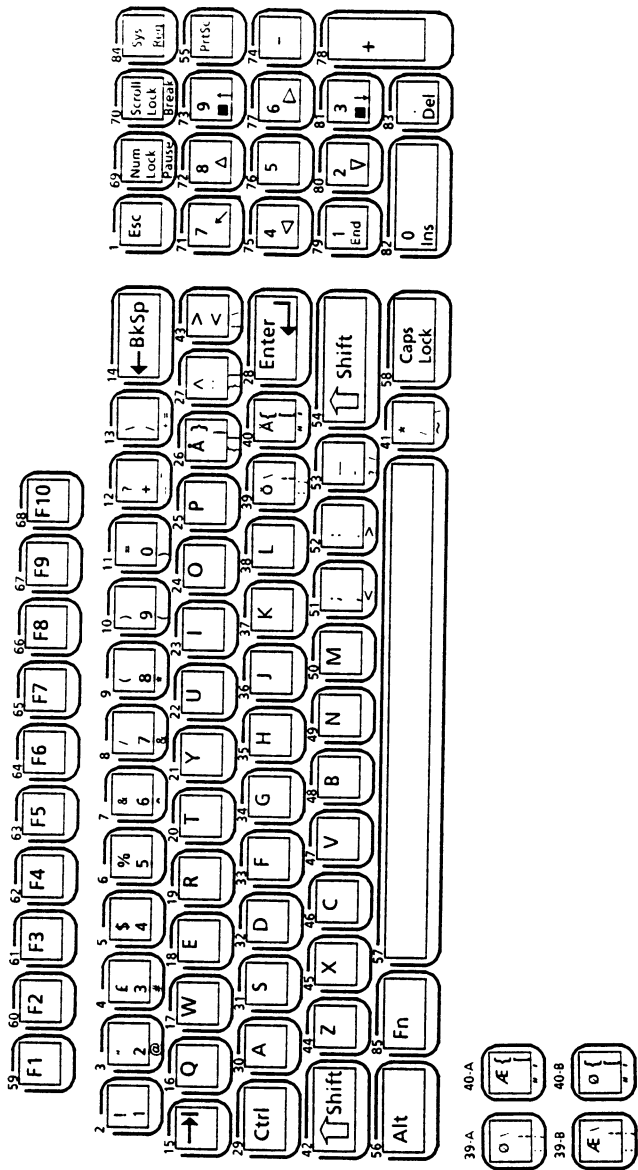

Figure 9-6 Italian Keyboard

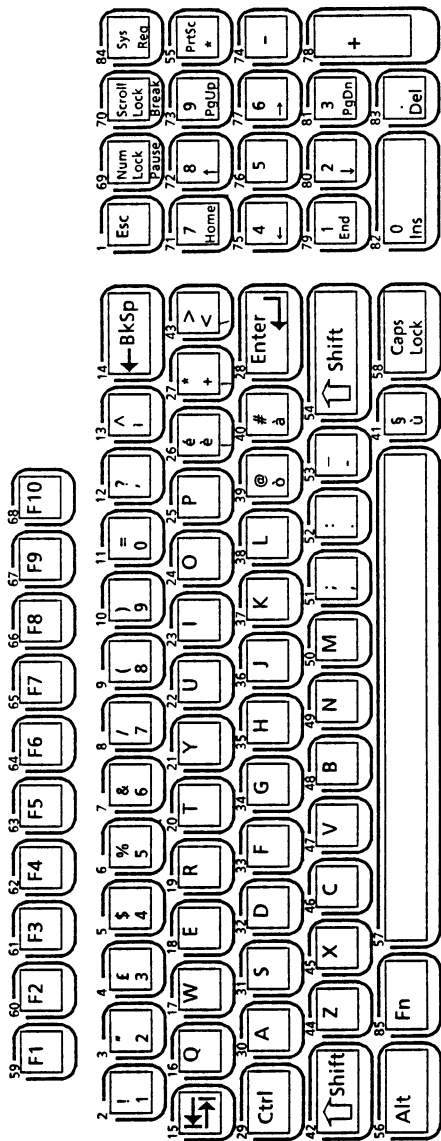
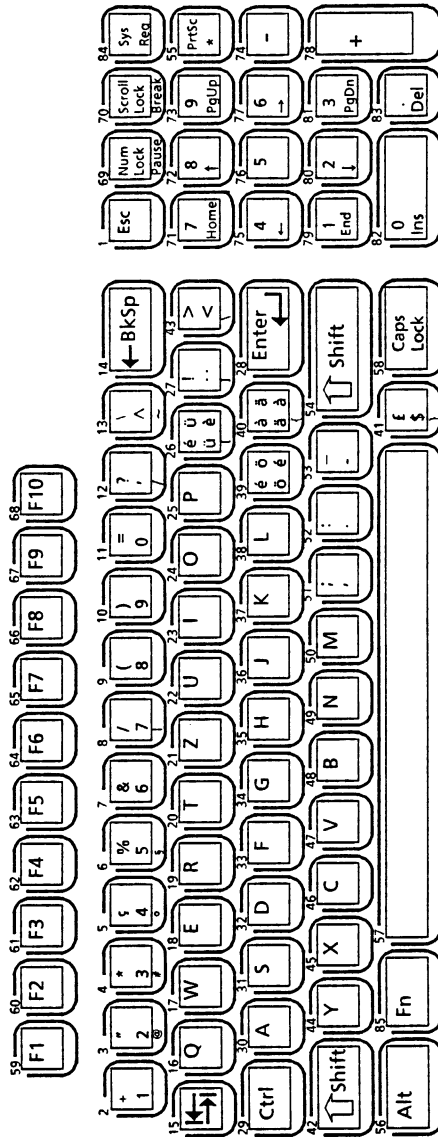

Figure 9-7 Switzerland Keyboard



9.4 Memory Expansion Option

The memory expansion provides an additional 3 megabytes of memory to the T3200.

Installing this option requires an internal computer modification that your dealer can perform. For extra memory capability, contact your dealer.

9.5 PC Floppy Link

The PC Floppy Link allows you to access a floppy disk drive connected to an IBM PC, PC/AT, PC/XT or compatible computer. The option consists of a board that fits into a PC, PC/AT or PC/XT expansion slot and a cable to connect it to the T3200.

The PC Floppy Link is documented in a separate manual that comes with your purchase of the option.

PAD8531-1

TOSHIBA CORPORATION
PRINTED IN JAPAN