

# FALCO QUICK SETUP MANUAL

FALCO 500  
SERIES  
VIDEO DISPLAY  
TERMINAL



# INTRODUCTION

This manual is designed for quick access and easy understanding of the features available in the Falco 500 Series of Video Display Terminals.

This manual will give the user an overview of features such as windowing, programming a

soft key and accessing the Setup screens. Detailed information is available in the Programmer's Manual for each terminal model.

The following table outlines the basic features of the terminals.

Feature	Falco 5000	Falco 500e	Falco 5220e	Falco 5600	Falco 5500e
Emulations:					
FALCO/PC Term	Yes	Yes	No	Yes	Yes
VT220/100/52	Yes	Yes	Yes	VT100	No
WY-50	Yes	Yes	No	Yes	Yes
TVI955/950	Yes	Yes	No	Yes	Yes
TVI925/920	Yes	Yes	No	Yes	Yes
ADDSVP	Yes	Yes	No	Yes	Yes
HZ1500	Yes	Yes	No	Yes	Yes
DG200	Yes	Yes	No	Yes	Yes
IBM3101	Yes	Yes	No	Yes	Yes
TEK4010/4014	Yes	Yes	Yes	Yes	No
Windows	6	6	6	6	6
Ports, Serial	3	2	2	2	2
Ports, Parallel	1	*	*	*	No
Pages, 24 lines, 132 col	8	4	4	4	4
Pages, 24 lines, 80 col	15	7	7	7	7
Falco Business Graphics I (560x390)	Yes	Yes	Yes	Yes	No
Falco Business Graphics II (1120x390)	Yes	**	**	**	No
Keyboard - Standard	ANSI	ANSI	F5220	ASCII	ASCII
Optional	ASCII AT	ASCII AT		AT	AT
Calculator/Calendar	Yes	Yes	Yes	Yes	Yes
Continuous Clock/Date	Yes	No	No	No	No

\* Optional expansion card which consists of:  
1 RS232/RS422 Serial Port and  
1 Centronic Parallel Port

\*\* Optional upgrade to Falco Business Graphics II

INSTALLING  
 DISPLAY  
 SETUP  
 COMMUNICATE  
 WINDOWING  
 CAPTURING  
 DESK-TOP

# UNPACKING

Note: Be sure to inspect the shipping carton and enclosed product for any evidence of damage that may have occurred in shipping. If any signs of mishandling are present, *contact the shipping carrier immediately.*

Save the terminal's box and packing material in the event the terminal needs to be moved, reshipped or returned for service.

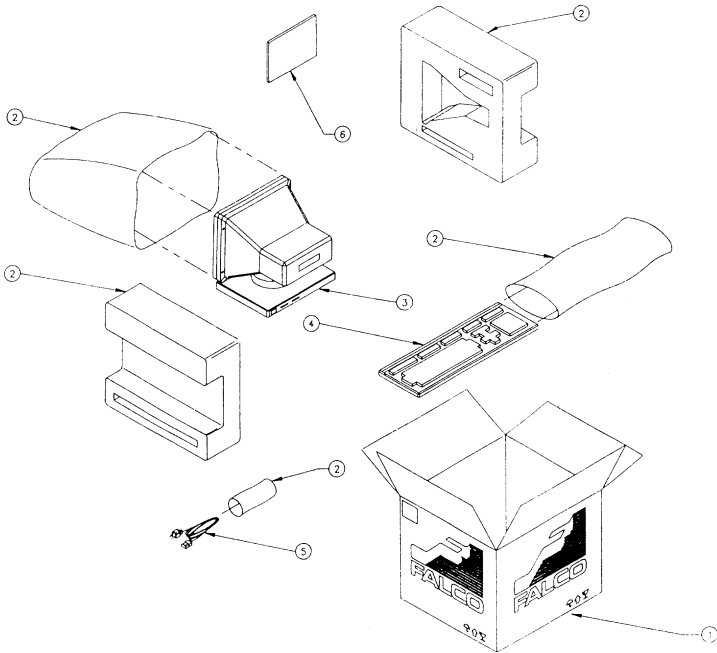

Be sure the box (1) contains all of the following items.

- (2) Packing Material
- (3) Display Monitor
- (4) Keyboard
- (5) Power Cord
- (6) Manual

# INSTALLING

1. Position the display unit on a cleared, well-ventilated desktop or table.
2. Locate the power switch (1) and be sure it is in the off position (O).
3. Plug the keyboard (2) into the left side of the terminal base (3). Notice the foot on the keyboard for adjustable height. Be sure the terminal is powered off whenever plugging or unplugging the keyboard.
4. Turn the unit around for easy access to power receptacle and communication ports. Connect the proper communication cables to the terminal ports (4) - (7).
5. Connect the power cord (8). Be sure the power source outlet is a three-pronged, grounded type, which matches the voltage rating of the terminal. The voltage rating is on the back label (9) along with the serial number (10) of the unit.
6. Adjust the display screen for comfortable viewing.

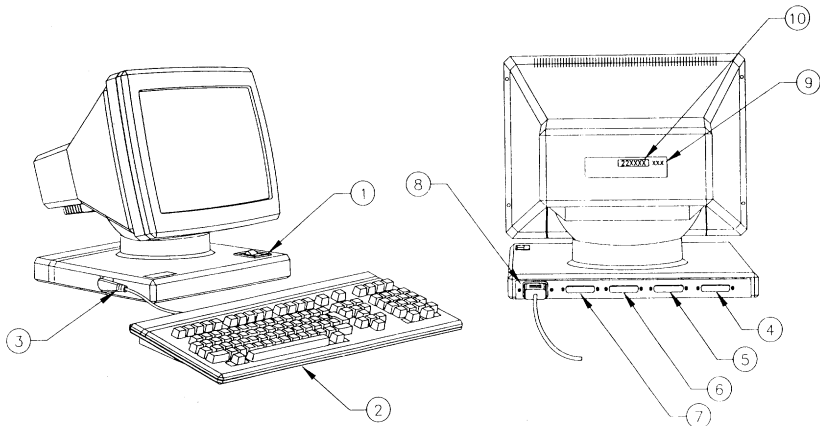

## POWER ON

Make sure the keyboard and the power cord are properly installed. Power the terminal on by turning the power switch to the 1 position. You will hear a beep signaling power on.

The terminal executes a series of self-tests at power on. If any test fails, the terminal will display a special screen, reporting the exact nature of the failure. For example, if the message reads "No Keyboard Response",

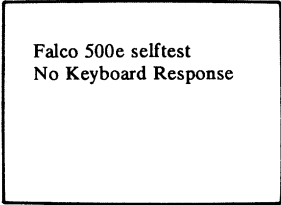

```
Falco 500e selftest  
No Keyboard Response
```

turn the terminal off and check to see if the keyboard is attached properly. After re-attaching the keyboard turn the terminal on again. Otherwise record the message as it appears on the screen and call for technical support. Whenever calling for technical

support be sure to have the serial number (located on the back of the terminal) and firmware version (located on the Setup screen) available. If the terminal passes all the self-tests then a second beep will be heard and you will see the following screen.

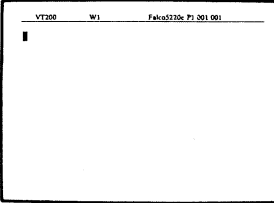

```
VT200 W1 Falco5230c P1.001.001  
|
```

After your terminal has been turned on for the first time, it is recommended that you execute a Factory Reset. Otherwise, do not perform a Factory Reset unless necessary, as this will return all the

Setup parameters to factory default and erase all programmed softkeys. A Factory Reset is executed in the Diagnostic Setup (see Setup Screens).

## SCREEN DISPLAY

- Status Line:** The status line appears as the top line of the display. It contains information on the 'status' of the terminal. After initial power on you will see the operating mode of the terminal, the window number (W1), the model name, the page number, cursor position coordinates and the date and clock functions, if applicable. When operating the terminal other information may be displayed. For example, when the **Lock** key is pressed 'CAP' or 'SHF' will appear on the left hand side. Or when operating in Block or Local mode the status line will indicate this with either a 'BLK' or 'LOC' to the left of the title field. The title field, which contains the terminal model at default, can be changed in the Terminal Setup screen.

VT200

W1

Falco5220e 01 001 001

- Brightness:** Hold the **Ctrl** key and press **▲** to increase or **▼** to decrease the brightness of the illuminated characters.
- Volume:** Hold the **Ctrl** key and press **▶** to increase or **◀** to decrease the volume of the bell.
- Cursor:** The cursor type can be changed in the Setup screens.
- Lines:** The number of lines can be altered in the Setup screens.
- Columns:** By default, the terminal is setup to display an 80 column screen. You can change this to 132 columns in the Terminal Setup screen.

DISPLAY

SETUP

COMMUNICATE

WINDOWING





SOFTWARE

DESK-TOP

# SETUP SCREENS

The Falco terminal is configured from the Setup screens. There are several levels of Setup screens from which to change various terminal options.

The following keys are used to access the Setup Menu, move to other Setup screens and to change or execute any Setup options.

<b>Active Keys in Setup</b>				
<b>Action</b>	<b>ANSI</b>	<b>F5220</b>	<b>ASCII</b>	<b>AT</b>
<b>Enter/exit Setup</b>	<b>Setup</b>	<b>Setup</b>	<b>Setup</b>	<b>Ctrl/Esc</b>
<b>Move to highlight new box</b>				
<b>Execute/change the field</b>	<b>Enter or Linefeed</b>	<b>Enter or Linefeed</b>	<b>Enter or Linefeed</b>	<b>End</b>
<b>Quit without changing</b>	<b>Shift/Esc</b>	<b>Shift/Esc</b>	<b>Shift/Esc</b>	<b>Shift/Esc</b>
<b>Go to next Setup screen</b>	<b>Next Scrn</b>	<b>Next Scrn</b>	<b>Next Page</b>	<b>Page Down</b>
<b>Go to Setup Directory</b>	<b>Prev Scrn</b>	<b>Prev Scrn</b>	<b>Prev Page</b>	<b>Page Up</b>

The following page shows two examples of how to use the Falco Setup screens. They will show how to program a new title in the status line

using an ANSI keyboard, and how to change the screen to reverse video using the AT keyboard.

Example 1: Using the ANSI keyboard to select the title field and enter a new status line title:

1. Press **Setup**.
2. Press **Next Scrn** three times to move to the Terminal Setup screen.
3. Use **↑ ↓ → ←** to highlight the title field.
4. Press **Enter**.
5. Type in a new title, up to

ten characters.

6. If you make a mistake press **Home** or **←** to start again, or **Shift/Esc** to exit without changing anything.
7. When the new title is ready, press **Enter** to program it into the status line.
8. Press **Setup** again to exit the Setup screens.

<u>Terminal Setup</u>	<u>Falco 5220e V0.00</u>
<input type="checkbox"/> Online <input type="checkbox"/> Full <input type="checkbox"/> No Wrap <input type="checkbox"/> Nor Video <input type="checkbox"/> Jump Scroll <input type="checkbox"/> 80 Col Window	
<input type="checkbox"/> Normal Print <input type="checkbox"/> Mon Off <input type="checkbox"/> Break <input type="checkbox"/> Setup <input type="checkbox"/> Status <input type="checkbox"/> Caplock	
<input type="checkbox"/> Key Set 1 <input type="checkbox"/> Deft Chr <input type="checkbox"/> No Marg Bell <input type="checkbox"/> Ext Dot <input type="checkbox"/> Cursor <input type="checkbox"/> Block	
Protect Att: <input type="checkbox"/> Normal <input type="checkbox"/> No Rev <input type="checkbox"/> No Unl <input type="checkbox"/> No Blink <input type="checkbox"/> Visible	
<input type="checkbox"/> Tab Table <input type="checkbox"/> Clr All Tabs <input type="checkbox"/> Set Tabs 8 <input type="checkbox"/> Typewriter Keys	
<input type="checkbox"/> Save <input type="checkbox"/> Recall <input type="checkbox"/> Title : Falco5220e	
Enter: <input style="width: 50px;" type="text"/>	
[Prev Scrn] = Dir [Next Scrn] [SETUP] = Exit [Enter][LF] = Select < arrows >	

Example 2: Using the AT keyboard to change the screen to reverse video:

1. Press **Ctrl/Esc**.
2. Press **Page Down** three times to move to the Terminal Setup screen.

3. Use **↑ ↓ → ←** to highlight the *Nor Video* field.
4. Press **End** to toggle the field to *Rev Video*.
5. Press **Ctrl/Esc** again to exit the Setup screens.

SETUP  
 COMMUNICATE  
 WINDOWING  
 SOFT-LEVS  
 DESK-TOP



# COMMUNICATION

The Falco 5000 comes standard with three serial ports and one parallel port. All three serial ports can be used as online host ports, printer ports or modem ports and can be configured for either an RS232C or RS422 interface. This is done through cable configurations.

The Falco 500e, 5220e, 5600 and 5500e come with two standard serial ports. An expansion card is available for the Falco 500e, 5220e and 5600 for additional port options.

Falco terminals come standard with a female communication port connector. A gender changer may be required at some installations.

The 12 pins of the communication interface listed below carry signals either into or out of the terminal. All pins, if connected at the terminal, can have some impact on the terminal's ability to communicate properly. Be sure only the pins required by your system are connected to the terminal.

Pin	Description	Mnemonic	Direction	Type
1	Frame Ground	FGND	-	Both
2	Transmit Data	TXD	output	RS232C
3*	Receive Data	RXD	input	Both
4	Request To Send	RTS	output	RS232C
5	Clear to Send	CTS	input	RS232C
7	Signal Ground	SGND	-	Both
8	Data Carrier Detect	DCD	input	RS232C
15	Receive Data A	RXA	input	RS422
17	Receive Data B	RXB	input	RS422
18*	422 Enable	Reserved	-	RS422
19	Transmit Data A	TXA	output	RS422
20	Data Terminal Ready	DTR	output	RS232C
25	Transmit Data B	TXB	output	RS422

\*Pins 3 and 18 should be connected to each other at the terminal end for an RS422 connection. They should not be connected through the cable.

# COMMUNICATION

The first line of the Communications Setup lets you go into the Setup for ports A, B and C. The second line lets you set the buffer size.

In addition to containing fields for accessing the Port Setup screens, the Communications Setup screen allows the user to clear garbled communications with the *Clr Comm* field, set the active window to automatically receive from the active port with the *Auto Main Rcv* field, set the receive buffer size and configure the ports for access to different windows.

The communications matrix allows you to select which window the keyboard will be active in, which port will be the main and which the auxiliary for that window and which will be the main and auxiliary receive port.

The example communications configuration below shows Port A to have 2 receive buffers allocated to it while Port B and C only have one, with a maximum of 4 for all three. The keyboard is active in Window 1 and Port A is the main port and Port B is the auxiliary. Window 2 has Port C as the receive port.

Comm Setup Falco 5220e V0.00

MAX

Rcv Buf (256 ea) XXXX Bytes available

Window	Key	Main	Rec	Aux	Rec	Window	Key	Main	Rec	Aux	Rec
1	<	<input type="text" value="A"/>	<input type="text" value="A"/>	<input type="text" value="B"/>	<input type="text" value="B"/>	4					
2		<input type="text" value="A"/>	<input type="text" value="C"/>	<input type="text" value="B"/>	<input type="text" value=""/>	5					
3						6					

[Prev Scrn] = Dir [Next Scrn] [SETUP] = Exit [Enter][LF] = Select < arrows >

COMMUNICATE | WINDOWING | SOFTWARES | DESK-TOP



# WINDOWING

The Window Setup is used to create additional windows, delete existing windows or alter existing window parameters.

The *Ln Available* field refers to the number of lines available for either a 132/80 column, 80 column or Bit Map graphic screen. When a 132 column screen is not necessary, it is possible to restrict the screen size to only 80 columns to save memory.

The window matrix shows the window number, the window type, the beginning screen line, the window size, the screen size, the page size and the number of pages.

The window number can

range from 1 to 6. The type can either be 132/80, 80 or bit map graphics. The begin line (*Beg*) and the window size (*Sz*) together cannot exceed 44 lines. The screen size or screen offset field (*Off/ScSz*) can be configured so the screen size in an alphanumeric window is less than the page size or the origin in a graphics window can be offset from the lower left hand corner. The page size (*PgSz*) can be selected to the user's needs. An average application program will run at a 24 line page size. The number of pages (*No*) can vary depending on the available memory.

Window Setup							FALCO 5220e V0.00						
New Window		Delete Window					132/80 80 only Bit Map						
Ln Available:						67	110	7*32					
Win	Type	Beg	Sz	Off/ScSz	PgSz	No	Win	Type	Beg	Sz	Off/ScSz	PgSz	No
1	132	1	43	24	24	1	4						
2							5						
3							6						
[Prev Scrn] = Dir [Next Scrn] [SETUP] = Exit [Enter][LF] = Select < arrows >													

WINDOWING  
SOFTWARE  
DESK-TOP

## WINDOWING

To create a new window, you must first verify that there is enough memory available for the number of lines and columns needed. This will be indicated by the numbers following the *Ln Available* field in Window Setup. There must be enough lines available for the number of lines in the window plus one for the status line. To free up extra memory, you can either decrease the number of pages or decrease the number of lines in existing windows.

To decrease the number of pages highlight the *No* field of the window matrix with

▲ ▼ ▸ ◀ and

press **Enter**. The terminal responds with 'Enter:', type in

a number less than the present value and press **Enter** again. The *Ln Available* field will reflect this change.

To decrease the number of screen lines highlight the *Off/ScSz* field of the window matrix and press **Enter**. The terminal will prompt you to enter a number. Enter a number less than the present value and press **Enter**. Then highlight the *PgSz* field and repeat the process used to change the *Off/ScSz*.

Once enough memory is present you can create a new window. To do this

use ▲ ▼ ▸ ◀ to highlight the *New Window* field and follow these steps.

Terminal response	From keyboard
New Window is highlighted	Press <b>Enter</b>
Enter window no:	Type new number (1-6) and press <b>Enter</b>
Enter window type:	Type 0, 1 or 2 and press <b>Enter</b>
Enter page size:	Type number of lines and press <b>Enter</b>
Enter page no:	Type number of pages and press <b>Enter</b>

To program a soft key, using the ANSI keyboard, follow these steps:

1. Press **Setup**.
2. Use **↑ ↓ → ←** to highlight the *Soft-key* field and press **Enter** again. This displays the Soft-Key Setup screen. The *Edit Key* field is highlighted.
3. Press **Enter** to edit a soft key.
4. The screen will prompt you to: "Select Key:[]."
5. Press the key to be programmed. (Soft keys can be programmed in their shifted states also). If a key is not a soft key, the terminal will display that message.
6. Use **←** or press **Home** to back up to the beginning of the program line.
7. Press **Del Line** to clear the program line.
8. Enter any data and/or control codes to be programmed into the key and then press **Enter**.
9. Note the terminal message, "Key Programmed".
10. Press **Setup** again to exit the Setup screens.

Soft-Key Setup

Falco 5220e V0.00

Window 1

XXXX Bytes Available

XX \*

[Prev Page]= Dir [Next Page] [SETUP]= Exit [Enter][LF]= Select < arrows >

All Falco 500 Series terminals offer fully re-configurable keyboards. The shaded keys

in the drawings show which keys are programmable.

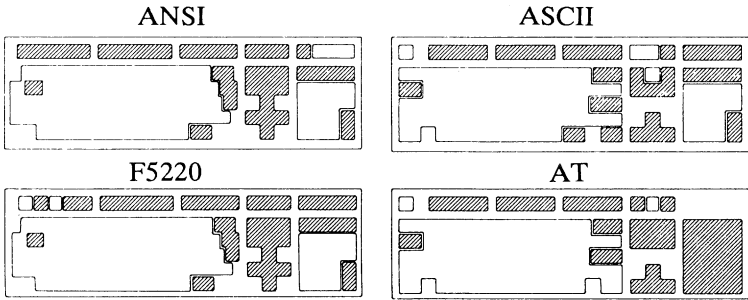

Each key can be programmed with up to 76 characters of data.

The terminal has over 2500 characters of memory, all of which can be used for soft key programming. (This memory is also used in the receive buffers and the creation of new windows).

Soft keys can be programmed in both the unshifted and

shifted states.

All soft keys contain a second bank of memory, for further re-programming. The second bank is enabled by the *Keyset* field in the Terminal Setup or Soft-key Setup screen.

The following table shows the keys used with the *Edit Key* field for programming soft keys.

Action	ANSI	F5220	ASCII	AT
Move to beginning of the programmed sequence	Home	Home	Home	Home
Move cursor right	➡	➡	➡	➡
Move cursor left does not erase contents	⬅	⬅	⬅	⬅
Enter next ASCII char from keyboard with bit 7 set	Shift/Funct	Shift/Funct	Shift/Funct	Shift/Alt
Erase from cursor to end of line	Del Line	Select	Del Line	Numeric Keypad 5
Quit programming, does not store changes in memory	Shift/Esc	Shift/Esc	Shift/Esc	Shift/Esc
Quit programming, does store the changes in memory	Enter	Enter	Enter	End

# DESK TOP FEATURES

Select the calculator through  
the **Ctrl/Lock** table.

**Esc** will exit the calculator.

ESC		F12	F13	F14	F15	F16
END		ANS	STO	REC	EXP	C/E
	0.	M	+/-	X/Y	=	/
		X	7	8	9	*
		Y	4	5	6	-
		R	1	2	3	+
			0		.	

The display, from top to bottom shows the memory value (M), the value of X, the value of Y and the answer (R).

The calculator can be moved

about the screen by pressing  

This will have no effect on the screen data.

The numeric keypad and function keys correspond to the screen layout as follows.

Action	ANSI	F5220	ASCII	AT	Screen
Digits 0-9	0-9	0-9	0-9	0-9	0-9
Decimal Point	.	.	.	.	.
Switches Plus or Minus	Ins Char	PF1	Ins Char	F9	+/-
Switches the Arguments	Del Char	PF2	Del Char	F10	X/Y
Equals	Clr Line	PF3	Clr Line	Enter	=
Divide	Repl	PF4	Repl	/	/
Multiply	-	-	-	*	*
Subtract	,	,	,	-	-
Add	Enter	Enter	Enter	+	+
Display Answer	F12	F12	F12	F4	ANS
Store value in memory	F13	F13	F13	F5	STO
Recall value in memory	F14	F14	F14	F6	REC
Exponential function	F15	Help	F15	F7	EXP
Clear	F16	Do	F16	F8	C/E



## DESK TOP FEATURES

To invoke the Desktop features, press **Ctrl/Lock** at the same time. The top left hand side of the screen will

display an option table. On the Falco 500e, the table will appear like this.

Esc	EXIT
F1	CALCULATOR
F2	CALENDAR

F2 will display the calendar. The first three months of 1987 will be displayed. To access different months, from January, 1901 to December,

2099, use the keys listed below. The calendar can be moved about the screen by pressing **↑ ↓ → ←**.

The calendar will not affect any data on the screen.

ANSI	F5220	ASCII	AT	Action
Esc	Esc	Esc	Esc	Exit
F1	F17	F1	F1	Move ahead month by month
F2	F18	F2	F2	Move back month by month
F3	F19	F3	F3	Move ahead year by year
F4	F20	F4	F4	Move back year by year

For Technical/Application  
Support:

In California call toll free:  
(800)-538-5383

Outside California call toll  
free:

(800)-835-8765

Falco Corporate:

(408)-745-7123

For Repair/Service Support:

1. Contact the Sales Agent where this terminal was purchased, or
2. Contact Falco Customer Service Center for a Return Goods Authorization (RGA) number.

The following publications are  
also available:

- \* Falco 5000 Programmer's  
Manual  
P/N 210037-000
- \* Falco 500e Programmer's  
Manual  
P/N 210035-000
- \* Falco 5220e  
Programmer's Manual  
P/N 210039-000
- \* Falco 5500e/5600  
Programmer's Manual  
P/N 210036-000
- \* Falco 500 Series Maintenance  
Manual  
P/N 210038-000

## Safety Information

1. Be sure the power source for the terminal matches the voltage label on the back of the unit.
2. The power source must be a three-pronged grounded receptacle.
3. Even when the terminal is powered off and unplugged, there are components which retain their high voltage charges. Only authorized service personnel should attempt to repair the unit.
4. Do not place the terminal in any environment that will restrict the air flow through the vents.

## FCC Warning

This equipment generates, uses and can radiate radio frequency energy and if not installed and used in accordance with the instructions in this manual, may cause interference to radio communications. The terminal has been tested and found to comply with the limits for a Class A computing device pursuant to Subpart J of Part 15 of FCC Rules, which are designed to provide reasonable protection against interference when operating in a commercial environment. Operation of this equipment in a residential zone is likely to cause interference in which case the user, at his own expense, will be required to take whatever measures may be necessary to correct the interference.

The use of properly shielded I/O cables is required when connecting this terminal to any and all optional equipment. Failure to do so may violate FCC rules.

Copyright © 1987 Falco Data Products, Inc. All rights reserved worldwide. Falco Data Products, Inc. assumes no responsibility for any errors that may appear in this manual. Falco Data Products, Inc. reserves the right to make any changes to this manual and to the products described without notice.

VT-220/100/52 are registered trademarks of Digital Equipment Corporation.

TVI955/950/925/920 are registered trademarks of TeleVideo Systems, Inc.

WY-50 is a registered trademark of Wyse Technology.

ADDSVP is a registered trademark of Applied Data Systems, Inc.

HZ1500 is a registered trademark of Hazeltine Corporation.

IBM3101 is a registered trademark of International Business Machines.

TEK4010/4014 are registered trademarks of Tektronix, Inc.

DG200 is a registered trademark of Data General Corporation.

Falco Data Products, Inc.  
1294 Hammerwood Ave.  
Sunnyvale, CA 94089

P/N 210018-000  
Rev A